

# Full HD Multiple Streams IR Bullet IP Camera User's Manual

Ver. 1.7

# Table of Contents

<b>1. Overview</b>	<b>2</b>
1.1 Features	2
1.2 Package Contents	3
1.3 Dimensions	4
1.4 Connectors	5
<b>2. Camera Cabling</b>	<b>7</b>
2.1 Connect Power	7
2.2 Connect Ethernet Cable	7
2.3 Connect Alarm I/O	7
<b>3. Installation</b>	<b>8</b>
3.1 Ceiling / Wall Mounting	8
3.2 Lens Adjustment (Vari-focal Lens only)	9
<b>4. System Requirements</b>	<b>10</b>
<b>5. Access Camera</b>	<b>11</b>
<b>6. Setup Video Resolution</b>	<b>15</b>
<b>7. Configuration Files Export / Import</b>	<b>16</b>
<b>Appendix A: Technical Specifications</b>	<b>17</b>
<b>Appendix B: Delete the Existing DC Viewer</b>	<b>21</b>
<b>Appendix C: Setup Internet Security</b>	<b>22</b>
<b>Appendix D: Video Resolution</b>	<b>23</b>
2M- Quad Streams	23
2M- Triple Streams	27
2M- Dual Streams	29
2M- Single Stream	29
2M Real time / 3M / 5M- Quad Streams	30
2M Real time / 3M / 5M- Triple Streams	35
2M Real time / 3M / 5M- Dual Streams	38
2M Real time / 3M / 5M- Single Streams	39

# 1. Overview







Supported with both H.264 and MJPEG standard, the product series not only features in superior Full HD resolution for real-time streaming at 25/30 fps, but also supplies D1 real-time streaming. With more computing power, the IP Camera could provide more flexibility for users and system managers.

## 1.1 Features

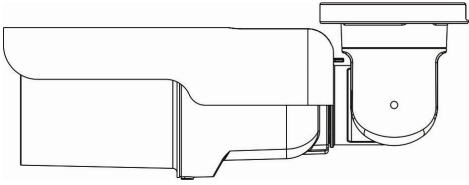
- Progressive Scan CMOS Sensor
- Quad Streams support
- Dual Streams, Full HD 1080P real-time + D1 real-time
- Quad Streams Compression:  
H.264 Baseline / Main / High Profile + MJPEG
- Multi-language support
- Tampering Alarm
- Wide Dynamic Range
- Remote Zoom & Focus (Motorized Lens)\*
- Motion Detection
- Privacy Masks
- Smart Picture Quality / 3D Noise Reduction
- Vertical View Mode (Image rotation by 90 degrees)
- Smart IR Mode
- Network Failure Detection
- Day/Night (ICR)
- IR LED Module (working distance up to 25m)
- Micro SD support
- Weatherproof (IP66 International)
- Sunshield\*
- Integrated Mounting Bracket with Cable Management
- ONVIF Support

## 1.2 Package Contents

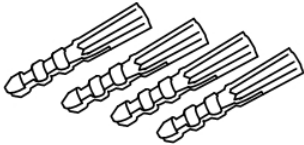
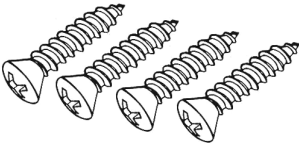
Please check the package contains the following items listed below.

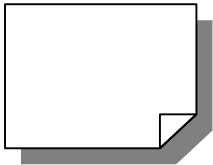
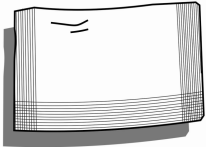
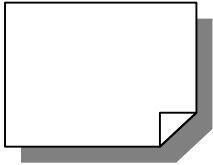
 <p>IR Bullet IP Camera (Cable included)</p>	 <p>Power Terminal Block (x1)</p>
 <p>M4 Inner Hex Wrench (x1)</p>	 <p>Alarm Terminal Block (x1)</p>
 <p>Plastic Screw Anchors (x5)</p>	 <p>M4 Self Tapping Screws (x5)</p>
 <p>CD (bundled software and documentation)</p>	 <p>Quick Guide</p>
 <p>Desiccant</p>	 <p>Desiccant User Guide</p>



## 1.3 Dimensions

The IP Camera's dimensions are shown below.

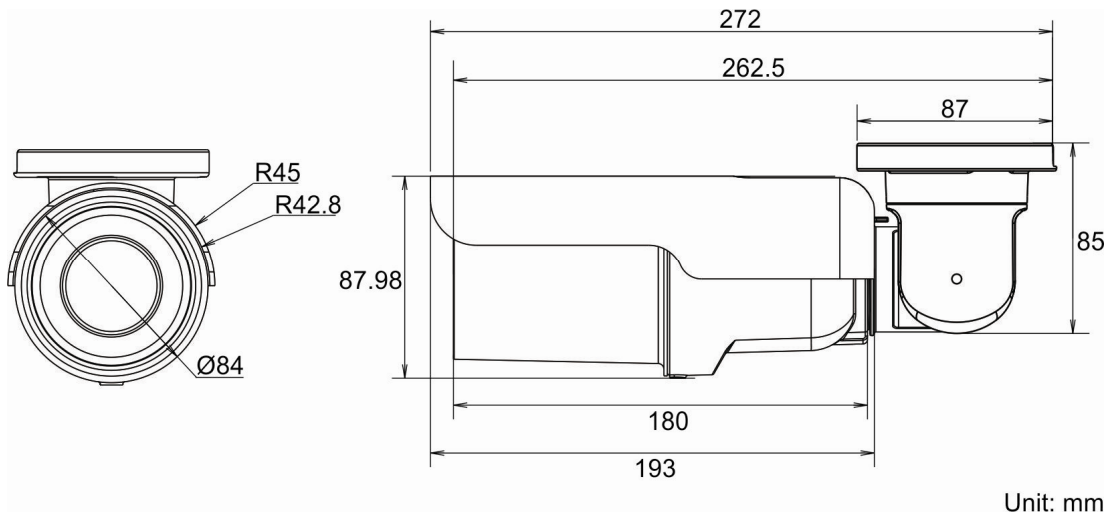

## 1.4 Connectors

The diagram below shows the IP Dome Camera's reset button and various connectors. Definition for each connector will be given as follows.

### All-in-one Cable

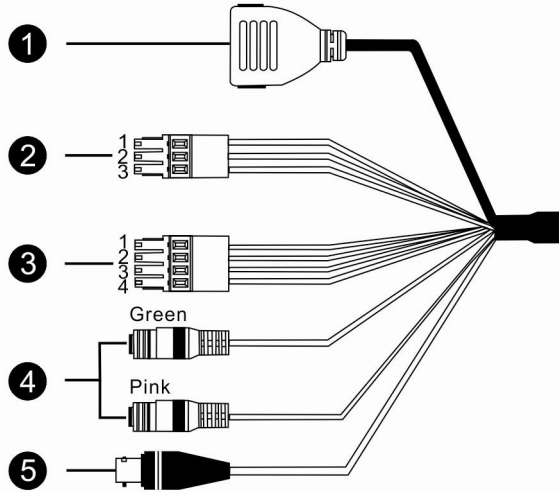

No	Cable	Pin	Definition	Remarks
1	Network (with PoE)	-	RJ-45 connector with LED	
2	Power (3-pin Terminal Block)	1	AC 24V-1   DC (-)	Power connection
		2	GND   Reserved	
		3	AC 24V-2   DC (+)	
3	Alarm (4-pin Terminal Block)	1	ALM_DI -	Alarm connection
		2	ALM_DI +	
		3	ALM_DO -	
		4	ALM_DO +	
4	Audio I/O	Pink	Line In/ Mic In	Two-way audio transmission
		Green	Line Out	
5	BNC	-	Analog Video Output	

### **Micro SD Card Slot / Reset Button**

Follow the steps below to reach the Micro SD Card Slot, Reboot Button and Factory Default Button on IP Camera:

#### **Step 1:**

Unscrew the screw on the Camera Housing and remove the Front Housing.

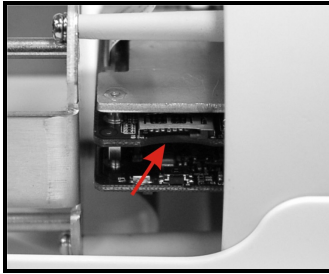
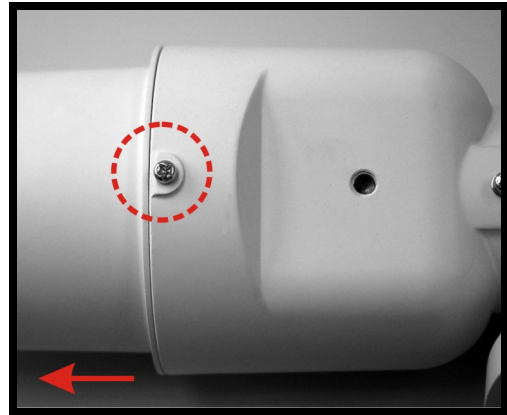

**Micro SD Card Slot**

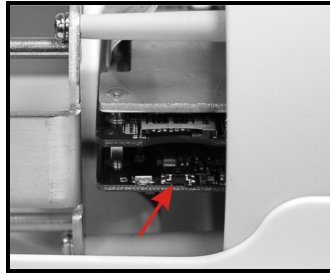

**Factory Default Button**

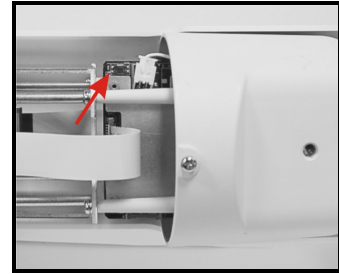

**Reboot Button**



**NOTE:** Before installing, please refer to Desiccant User Guide in the package to place the Desiccant in the Camera to prevent moisture from condensing on IP Camera's Glass Cover.

## 2. Camera Cabling

Please follow the instructions below to complete IP Camera connection.

### 2.1 Connect Power

Please refer to [Section: Connectors](#). Alternatively, connect the Ethernet cable to the camera's PoE port and plug the other end of the cable into a PoE switch.



**NOTE:** If using PoE, make sure Power Sourcing Equipment (PSE) is in use in the network.

### 2.2 Connect Ethernet Cable

Use of Category 5 Ethernet cable is recommended for network connection; to have best transmission quality, cable length shall not exceed 100 meters. Connect one end of the Ethernet cable to the RJ-45 connector of the IP Camera, and the other end of the cable to the network switch or PC.



**NOTE:** In some cases, you may need use an Ethernet crossover cable when connecting the IP Camera directly to the PC.

Check the status of the link indicator and activity indicator LEDs; if the LEDs are unlit, please check LAN connection.

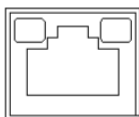

Green Link Light indicates good network connection.

Orange Activity Light flashes for network activity indication.

### 2.3 Connect Alarm I/O

The camera equips one alarm input and one relay output for alarm application. Please refer to the label on the alarm terminal block and connect the alarm wiring accordingly.

### 3. Installation

Please read the instructions provided in this chapter thoroughly before installing the IP Bullet Camera.

#### 3.1 Ceiling / Wall Mounting

The IR Bullet IP Camera can be installed directly on a wall or ceiling with the integrated 2-axis adjustable Bracket Mount. Please note that the wall or ceiling must have enough strength to support the IP Camera.

Follow the steps below to install the IP Camera:

**Step 1:**

Unpack the IR Bullet IP Camera package and take out the IP Camera.

**Step 2:**

Connect the power / Ethernet / alarm / audio wires from ceiling or wall to the corresponding connectors of the camera's All-in-one Cable.

**Step 3:**

Fix the IP Camera's Bracket on the ceiling / wall with three supplied self tapping screws.

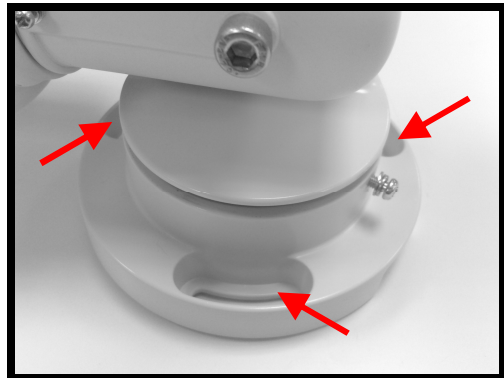

**Step 4:**

Loosen the screw indicated in the figure, and adjust the camera to a desired position, and tighten the screw to secure the camera.

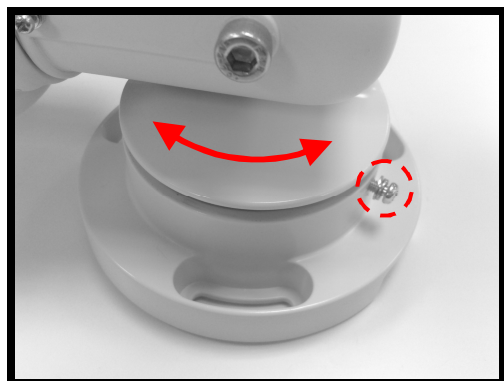

**Step 5:**

Use the supplied Inner Hex Wrench and cross screwdriver to loosen the hex bolt / screw on the side of the Bracket Mount and the Camera Housing to adjust the position of the IP Camera.

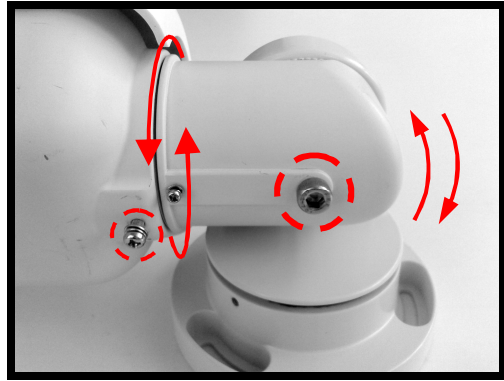

## 3.2 Lens Adjustment (Vari-focal Lens only)

**Step 1:**

Unscrew the screw on the Camera Housing and remove the Front Housing.



**Step 2:**

Power up the IP Camera. Please refer to [Section: Connectors](#) for more cabling installing details.

**Step 3:**

Access the Camera Browser-viewer for viewing images. Please refer to [Section: Access Camera](#) for further details.

**Step 4:**

Adjust the Zoom / Focus to set the desired zoom / focal length.

**Step 5:**

Put the Front Housing back, and make sure it's well attached to the Camera Housing, and tighten the screw.

## 4. System Requirements

To perform the IP Camera via web browser, please ensure your PC is in good network connection, and meet system requirements as described below.

Items	System Requirement
<b>Personal Computer</b>	1. Intel® Pentium® M, 2.16 GHz or Intel® Core™2 Duo, 2.0 GHz 2. 2 GB RAM or more
<b>Operating System</b>	Windows VISTA / Windows XP / Windows 7
<b>Web Browser</b>	Microsoft Internet Explorer 6.0 or later Firefox Chrome Safari
<b>Network Card</b>	10Base-T (10 Mbps) or 100Base-TX (100 Mbps) operation
<b>Viewer</b>	ActiveX control plug-in for Microsoft IE

## 5. Access Camera

For initial access to the IP Camera, users can search the camera through the installer program: DeviceSearch.exe, which can be found in “DeviceSearch” folder in the supplied CD.

### Device Search Software Setup

**Step 1:** Double click on the program Device Search.exe. After its window appears, click on the <Device Search> button on the top side.

**Step 2:** The security alert window will pop up. Click on <Unblock> to continue.

### Device Search

**Step 3:** Click on <Device Search> again, and all the finding IP devices will be listed in the page. The IP Camera’s default IP address is: **192.168.0.250**.

**Step 4:** Double click or right click and select <Browse> to access the camera directly via web browser.

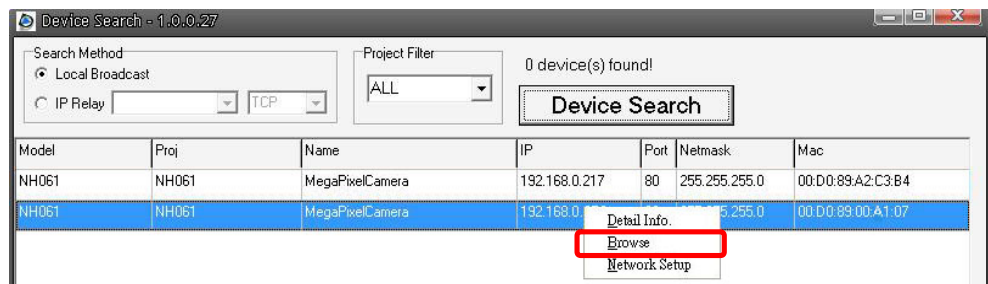

**Step 5:** Then the prompt window of request for entering default username and password will appear for logging in to the IP Camera.

The default login ID and password for the Administrator are:

Login ID	Password
Admin	1234



**NOTE:** ID and password are case sensitive.



**NOTE:** It is strongly advised that administrator’s password be altered for the security concerns. Refer to [Full HD Multiple Streams IP Camera Menu Tree](#) for further details.



Additionally, users can change the IP Camera's network property, either DHCP or Static IP, directly in the device finding list. Refer to the following section for changing the IP Camera's network property.

### **Example of Changing IP Camera's Network Property**

Users can directly change an IP Camera's network property, ex. from static IP to DHCP, in the finding device list. The way to change the IP Camera's network property is specified below:

**Step 1:** In the finding device list, click on the IP Camera that you would like to change its network property. On the selected item, right click and select "Network Setup." Meanwhile, record the IP Camera's MAC address, for future identification.

**Step 2:** The "Network Setup" page will come out. Select "DHCP," and press "Apply" button down the page.

**Step 3:** Click on <OK> on the Note of setting change. Wait for one minute to re-search the IP Camera.

**Step 4:** Click on the <Device Search> button to search all the devices. Then select the IP Camera with the correct MAC address. Double click on the IP Camera, and the login window will come out.

**Step 5:** Enter User name and Password to access the IP Camera.

### **Installing DC Viewer Software Online**

For the initial access to the IP Camera, a client program, DC Viewer, will be automatically installed to your PC when connecting to the IP Camera.

If the Web browser doesn't allow DC Viewer installation, please check the Internet security settings or ActiveX controls and plug-ins settings (refer to [Section: Setup Internet Security](#)) to continue the process.

The Information Bar (just below the URL bar) may come out and ask for permission to install the ActiveX Control for displaying video in browser. Right click on the Information Bar and select <Install ActiveX Control...> to allow the installation.

The download procedure of DC Viewer software is specified as follows.

**Step 1:** In the DC Viewer installation window, click on <Next> to start installation.

**Step 2:** The status bar will show the installation progress. After the installation is completed, click on <Finish> to exit the installation process.

**Step 3:** Click on <Finish> to close the DC Viewer installation page.

Once the DC Viewer is successfully installed, the IP Camera's Home page will be able to correctly display as the figure below.

### Fixed-focal / Vari-focal Lens Model

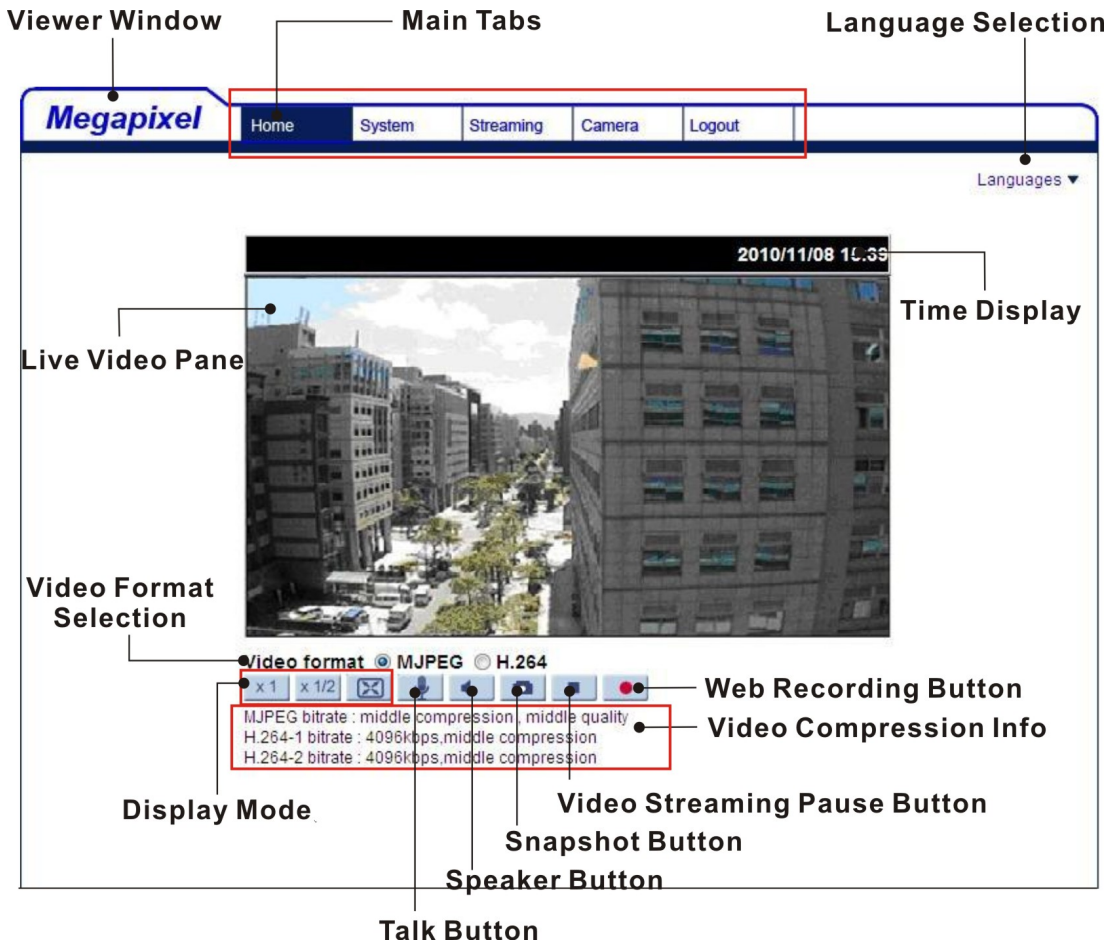

## Motorized Lens Model

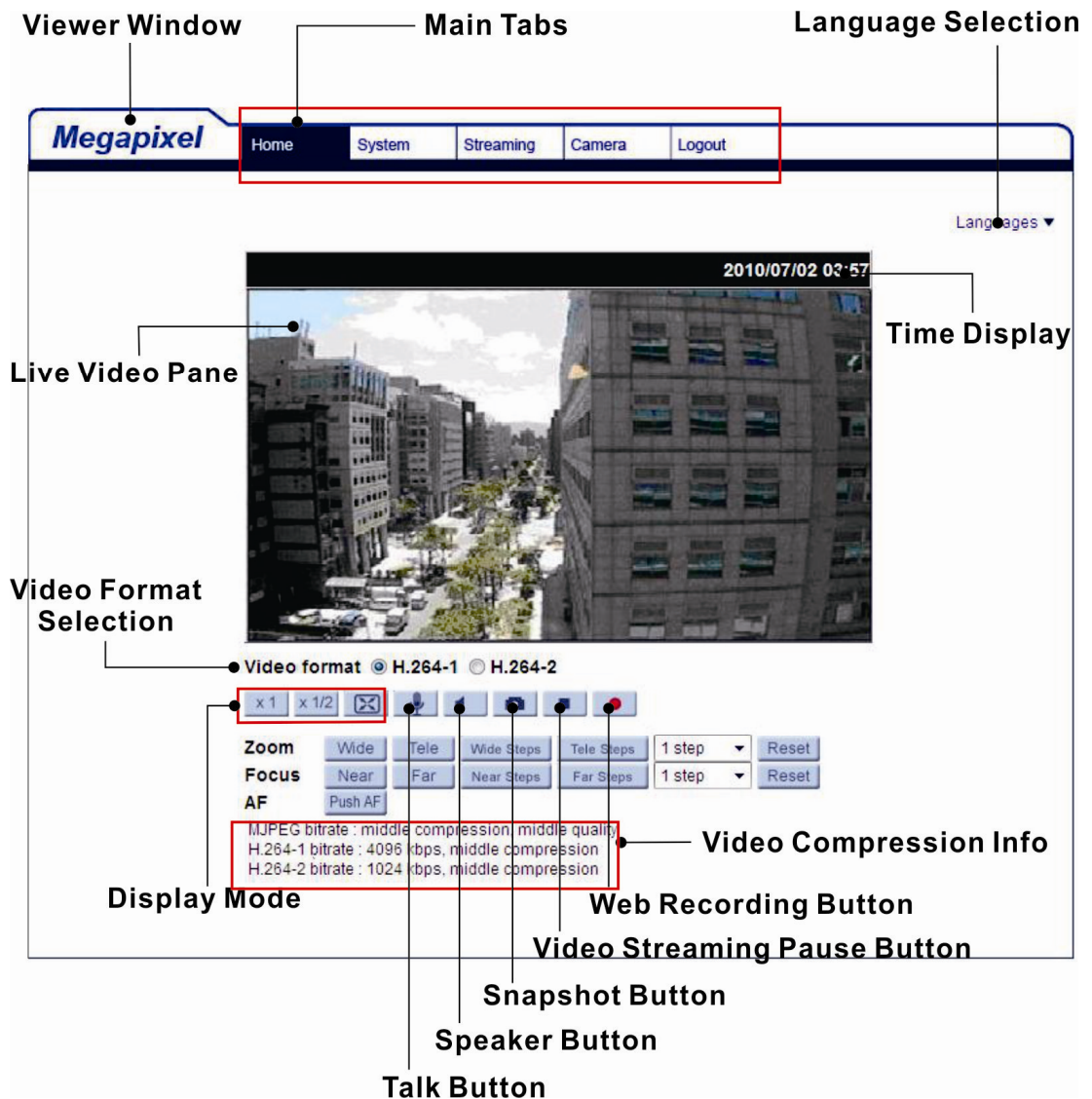

## Image and Focus Adjustment

The image displays on the Home page when successfully accessing to the IP Camera. Adjust zoom and focus as necessary to produce a clear image.



**Note:** Please refer to [Full HD Multiple Streams IP Camera Menu Tree](#) for more button function detail.

## 6. Setup Video Resolution

Users can setup Video Resolution on Video Format page of the user-friendly browser-based configuration interface.

Video Format can be found under this path: **Streaming> Video Format**.

The screenshot shows the Megapixel configuration interface. The top navigation bar includes 'Home', 'System', 'Streaming', 'Camera', and 'Logout'. The 'Streaming' menu item is highlighted with a red box. On the left sidebar, the 'Video Format' menu item is also highlighted with a red box. The main content area is titled 'Video Format' and contains the following sections:

- Video Resolution :** A dropdown menu showing 'H.264 + H.264 + H.264 + H.264'. Below it are four rows of settings:
  - H.264-1 format : 1920 x 1080 (15 fps)
  - H.264-2 format : 1280 x 1024 (15 fps)
  - H.264-3 format : 1280 x 720 (15 fps)
  - H.264-4 format : 720 x 480 (15 fps)
 A 'Save' button is located below these settings.
- Note :** Image attachment by FTP or E-mail will be available only while MJPEG streaming is selected.
- Text Overlay Settings :** Includes checkboxes for 'Include date', 'Include time', and 'Include text string' (with an input field). A 'Save' button is below.
- Video Rotate Type :** A dropdown menu set to 'Normal video'. A 'Save' button is below.
- GOV Settings :** Includes input fields for GOV Length for each format:
  - H.264-1 GOV Length : 60
  - H.264-2 GOV Length : 60
  - H.264-3 GOV Length : 30
  - H.264-4 GOV Length : 30
 A 'Save' button is below.
- H.264 Profile :** Includes dropdown menus for profile selection for each format:
  - H.264-1 : Main profile
  - H.264-2 : Main profile
  - H.264-3 : Main profile
  - H.264-4 : Main profile
 A 'Save' button is below.

The default value of Video Resolution is as below:

<b>2M</b>	H.264- 1920 x 1080 (15 fps) + H.264- 1280 x 720 (30 fps)
<b>2M Real time</b>	
<b>3M</b>	H.264- 1920 x 1080 (30 fps) + H.264 720 x 480 (30 fps)
<b>5M</b>	

For more Video Resolution combination detail, please refer to [Appendix: Video Resolution](#). Click on <Save> to confirm the setting.

## 7. Configuration Files Export / Import

To export / import configuration files, users can access the Maintenance page on the user-friendly browser-based configuration interface.

The Maintenance setting can be found under this path: **System> Maintenance**.

Users can export configuration files to a specified location and retrieve data by uploading an existing configuration file to the IP Camera. It is especially convenient to make multiple cameras having the same configuration.

### **Export**

Users can save the system settings by exporting the configuration file (.bin) to a specified location for future use. Click on the <Export> button, and the popup File Download window will come out. Click on <Save> and specify a desired location for saving the configuration file.

### **Upload**

To copy an existing configuration file to the IP Camera, please first click on <Browse> to select the configuration file, and then click on the <Upload> button for uploading.

## Appendix A: Technical Specifications

Camera		2M	2M Real time
Image Sensor		1/2.7" Progressive CMOS	
Effective Pixels		1920(H) x 1080(V)	
Minimum Illumination		0.2 lux (Color) 0.02 lux (B/W)	
White Balance		Manual / AWB / ATW	
Shutter Speed		1~ 1/10000 sec.	
Lens			
Lens		Vari-focal / Motorized / Board	Vari-focal / Motorized / Board / 3x AF
Focal Length		Vari-focal / Motorized / 3x AF- 3 ~ 9 mm Board- 4 mm	
F Number		Vari-focal / Motorized- F1.2 3x AF- F1.2 (Wide); F2.1 (Tele) Board- F1.5	
FOV		Vari-focal / Motorized- 103.5° (Wide); 34.3° (Tele) 3x AF- 92.93° (Wide) ~ 30.9° (Tele) Board- 78°	
Operation			
Multiple Languages		English / French / German / Italian / Korean / Simplified Chinese / Traditional Chinese / Russian	
Image Setting	Backlight Compensation	On / Off	
	White Balance	Auto / Manual	
	Noise Reduction (3D)	On / Off	
	Wide Dynamic Range	On / Off	
	Privacy Mask	On / Off	
	Brightness	Manual	
	Exposure	Auto / Manual	
	Sharpness	Manual	
	Contrast	Manual	
	Saturation	Manual	
	Hue	Manual	
	Digital Zoom	Support	
	Motion Detection	On / Off	
	Privacy Mask Type	Color	
	ICR	Auto / On / Off / Smart	
ICR + IR LED	Auto/ LED On / LED Off / Smart IR / Light Sensor		
Tampering Alarm	On / Off		
Audio	Two-way Audio	Line in, Line out	
	Compression	G.711 / G.726	
Network			
Interface		RJ-45, 10/100 Mbps Ethernet	
Video Compression		H.264 / MJPEG	
Video Streaming		Dual Streams- H.264 + H.264 / MJPEG Quad Streams- H.264 + H.264 + H.264 / MJPEG	
Video Resolution		H.264- Full HD 1080P / SXGA / HD 720P / XGA / SVGA / D1 / VGA / CIF MJPEG- Full HD 1080P / SXGA / HD 720P / XGA / SVGA / D1 / VGA / CIF	
Protocol		IPv4/v6, TCP/IP, UDP, RTP, RTSP, HTTP, HTTPS, ICMP, FTP, SMTP, DHCP, PPPoE, UPnP, IGMP, SNMP, QoS, ONVIF	
Security		HTTPS / IP Filter / IEEE 802.1x	
Alarm	Input	1 Set 5V 10kΩ pull up	
	Output	1 Set Photo Relay Output 300V DC/AC	
Event Notification		HTTP / FTP / SMTP	
Micro SD		microSDHC 32GB support	
Supported Web Browser		Internet Explorer (6.0+) / Chrome / Firefox / Safari	
User Account		20	
Password Levels		User and Administrator	

<b>Mechanical</b>		
Built-in IR Illuminator	Working distance	up to 25 m
	Wavelength	850 nm
	Number of LEDs	23
LED Indicator		Power / Link / ACT
Connectors	Alarm	4 Pin Terminal Block
	Power	3 Pin Terminal Block
	Ethernet	RJ-45
	Analog Video	1.0 Vp-p / 75 Ω, BNC
	Audio	Line in, Line out
<b>General</b>		
Operating Temperature	-10°C ~ 50°C (14°F ~ 122°F) w/ Heater, Powered by DC 12V / AC 24V: -40°C ~ 50°C (-40°F ~ 122°F)	
Humidity	10% ~ 90%, No Condensation	
Weatherproof Standard	IP66	
Dimension	ø 84 x 180 mm (ø 3.3 x 7.1 in.) ø 84 x 193 mm (ø 3.3 x 7.6 in.) w/ Sunshild	
Weight	940 g (2.07 lb)	
Power Source	DC 12V / AC 24V / PoE	
Power Consumption	System: 5 W (Built-in IR Illuminator: +3 W, Motorized Lens: +3.6 W, Heater: +12 W)	
Regulatory	CE / FCC / RoHS	

(\*) Optional

Camera		3M	5M
Image Sensor		1/2.7" Progressive CMOS	1/2.5" 5M Progressive CMOS
Effective Pixels		2048(H) x 1536(V)	2592(H) x 1944(V)
Minimum Illumination		0.2 lux (Color) 0.02 lux (B/W)	TBD
White Balance		Manual / AWB / ATW	
Shutter Speed		1~ 1/10000 sec.	
Lens			
Lens		Vari-focal / Motorized / Board	
Focal Length		Vari-focal / Motorized- 3 ~ 9 mm Board- 4 mm	
F Number		Vari-focal / Motorized- F1.2 Board- F1.5	
FOV		Vari-focal / Motorized- 103.5° (Wide); 34.3° (Tele) Board- 78°	
Operation			
Multiple Languages		English / French / German / Italian / Korean / Simplified Chinese / Traditional Chinese / Russian	
Image Setting	Backlight Compensation	On / Off	
	White Balance	Auto / Manual	
	Noise Reduction (3D)	On / Off	
	Wide Dynamic Range	On / Off	
	Privacy Mask	On / Off	
	Brightness	Manual	
	Exposure	Auto / Manual	
	Sharpness	Manual	
	Contrast	Manual	
	Saturation	Manual	
	Hue	Manual	
	Digital Zoom	Support	
	Motion Detection	On / Off	
	Privacy Mask Type	Color	
	ICR	Auto / On / Off / Smart	
ICR + IR LED	Auto/ LED On / LED Off / Smart IR / Light Sensor		
Tampering Alarm	On / Off		
Audio	Two-way Audio	Line in, Line out	
	Compression	G.711/G.726	
Network			
Interface		RJ-45, 10/100 Mbps Ethernet	
Video Compression		H.264 / MJPEG	
Video Streaming	Single Stream- 2048 x 1536		Single Stream- 2592 x 1944 / 2048 x 1536
	Dual Streams- H.264 + H.264 / MJPEG Quad Streams- H.264 + H.264 + H.264 + H.264 / MJPEG		
Video Resolution	H.264- 2048 x 1536 (3M)		H.264- 2592 x 1944 (5M) / 2048 x 1536 (3M)
	H.264- Full HD 1080P / SXGA / HD 720P / XGA / SVGA / D1 / VGA / CIF MJPEG- Full HD 1080P / SXGA / HD 720P / XGA / SVGA / D1 / VGA / CIF		
'Protocol		IPv4/v6, TCP/IP, UDP, RTP, RTSP, HTTP, HTTPS, ICMP, FTP, SMTP, DHCP, PPPoE, UPnP, IGMP, SNMP, QoS, ONVIF	
Security		HTTPS / IP Filter / IEEE 802.1x	
Alarm	Input	1 Set 5V 10kΩ pull up	
	Output	1 Set Photo Relay Output 300V DC/AC	
Event Notification		HTTP / FTP / SMTP	
Micro SD		microSDHC 32GB support	
Supported Web Browser		Internet Explorer (6.0+)/ Chrome / Firefox / Safari	
User Account		20	
Password Levels		User and Administrator	



<b>Mechanical</b>		
Built-in IR Illuminator*	Working distance	up to 25 m
	Wavelength	850 nm
	Number of LEDs	23
LED Indicator		Power / Link / ACT
Connectors	Alarm	4 Pin Terminal Block
	Power	3 Pin Terminal Block
	Ethernet	RJ-45
	Analog Video	1.0 Vp-p / 75 Ω, BNC
	Audio	Line in, Line out
<b>General</b>		
Operating Temperature	-10°C ~ 50°C (14° ~ 122° F) w/ Heater, Powered by DC 12V / AC 24V: -40°C ~ 50°C (-40° ~ 122° F)	
Humidity	10% ~ 90%, No Condensation	
Weatherproof Standard	IP66	
Dimension	ø 84 x 180 mm (ø 3.3 x 7.1 in.) ø 84 x 193 mm (ø 3.3 x 7.6 in.) w/ Sunshild	
Weight	940 g (2.07 lb)	
Power Source	DC 12V / AC 24V / PoE	
Power Consumption	System: 5 W (Built-in IR Illuminator: +3 W, Motorized Lens: +3.6 W, Heater: +12 W)	
Regulatory	CE / FCC / RoHS	

(\*) Optional

## Appendix B: Delete the Existing DC Viewer

For users who have installed the DC Viewer in the PC previously, please first remove the existing DC Viewer from the PC before accessing to the IP Camera.

### **Deleting the DC Viewer**

In the Windows <Start Menu>, activate <Control Panel>, and then double click on <Add or Remove Programs>. In the <Currently installed programs> list, select <DCViewer> and click on the button <Remove> to uninstall the existing DC Viewer.

### **Deleting Temporary Internet Files**

To improve browser performance, it is suggested to clean up the all the files in the Temporary Internet Files.

The procedure is as follows:

**Step 1:** Click on the <Tools> tab on the menu bar and select <Internet Options>.

**Step 2:** Click on the <Delete> button under <Browsing history> section. Then click on the <Delete Files> button under the <Temporary Internet files> section.

**Step 3:** A confirmation window will pop up. Click on <Yes> to start deleting the files.

## Appendix C: Setup Internet Security

If ActiveX control installation is blocked, please either set Internet security level to default or change ActiveX controls and plug-ins settings.

### **Internet Security Level: Default**

**Step 1:** Start the Internet Explorer (IE).

**Step 2:** Click on the <Tools> tab on the menu bar and select <Internet Options>.

**Step 3:** Click on the <Security> tab, and select <Internet> zone.

**Step 4:** Down the page, click on the <Default Level> button and click on <OK> to confirm the setting. Close the browser window, and restart a new one later to access the IP Camera.

### **ActiveX Controls and Plug-ins Settings**

**Step 1:** Repeat **Steps 1~3** of the previous section above.

**Step 2:** Down the page, click on the <Custom Level> button to change ActiveX controls and plug-ins settings. The Security Settings window will pop up.

**Step 3:** Under <ActiveX controls and plug-ins>, set **ALL** items (as listed below) to <Enable> or <Prompt>. Please note that the items vary by IE version.

#### **ActiveX controls and plug-ins settings:**

1. Allow previously unused ActiveX controls to run without prompt.
2. Allow Scriptlets.
3. Automatic prompting for ActiveX controls.
4. Binary and script behaviors.
5. Display video and animation on a webpage that does not use external media player.
6. Download signed ActiveX controls.
7. Download unsigned ActiveX controls.
8. Initialize and script ActiveX controls not marked as safe for scripting.
9. Run ActiveX controls and plug-ins.
10. Script ActiveX controls marked safe for scripting.

**Step 4:** Click on <OK> to accept the settings and close the Security Settings window.

**Step 5:** Click on <OK> to close the Internet Options screen.

**Step 6:** Close the browser window, and restart a new one later to access the IP Camera.

# Appendix D: Video Resolution

## 2M- Quad Streams

H.264 + H.264 + H.264 + H.264 / MJPEG					
H.264-1	H.264-2	H.264-3	H.264-4 / MJPEG		
1920 x 1080 (15 fps)	1280 x 1024 (15 fps)	720 x 480 (15 fps)	352 x 240 (30 fps)		
		640 x 480 (15 fps)	352 x 240 (30 fps)		
		352 x 240 (30 fps)	352 x 240 (30 fps)		
	1280 x 720 (15 fps)	800 x 600 (15 fps)		720 x 480 (15 fps)	
				640 x 480 (15 fps)	
				352 x 240 (30 fps)	
		720 x 480 (15 fps)		720 x 480 (15 fps)	720 x 480 (15 fps)
				640 x 480 (15 fps)	640 x 480 (15 fps)
				720 x 480 (30 fps)	352 x 240 (30 fps)
				640 x 480 (15 fps)	640 x 480 (30 fps)
				640 x 480 (30 fps)	352 x 240 (30 fps)
	1024 x 768 (15 fps)	800 x 600 (15 fps)		720 x 480 (15 fps)	
				640 x 480 (15 fps)	
				352 x 240 (30 fps)	
		720 x 480 (15 fps)		720 x 480 (30 fps)	640 x 480 (30 fps)
				720 x 480 (30 fps)	352 x 240 (30 fps)
				640 x 480 (15 fps)	640 x 480 (30 fps)
	800 x 600 (15 fps)	800 x 600 (15 fps)		720 x 480 (30 fps)	
				640 x 480 (30 fps)	
				352 x 240 (30 fps)	
		720 x 480 (15 fps)		800 x 600 (30 fps)	352 x 240 (30 fps)
				720 x 480 (15 fps)	720 x 480 (30 fps)
				720 x 480 (30 fps)	640 x 480 (30 fps)
	800 x 600 (30 fps)	720 x 480 (30 fps)		640 x 480 (30 fps)	
				352 x 240 (30 fps)	
				352 x 240 (30 fps)	
	720 x 480 (15 fps)	720 x 480 (30 fps)		720 x 480 (30 fps)	
				640 x 480 (30 fps)	
			640 x 480 (30 fps)	640 x 480 (30 fps)	
	720 x 480 (30 fps)	720 x 480 (30 fps)		352 x 240 (30 fps)	
			352 x 240 (30 fps)		
			352 x 240 (30 fps)		
640 x 480 (30 fps)	640 x 480 (30 fps)		640 x 480 (30 fps)		
			352 x 240 (30 fps)		
		352 x 240 (30 fps)	352 x 240 (30 fps)		
352 x 240 (30 fps)	352 x 240 (30 fps)		352 x 240 (30 fps)		
			352 x 240 (30 fps)		

H.264 + H.264 + H.264 + H.264 / MJPEG					
H.264-1	H.264-2	H.264-3	H.264-4 / MJPEG		
1280 x 1024 (15 fps)	1280 x 1024 (15 fps)	1280 x 720 (15 fps)	720 x 480 (30 fps)		
			640 x 480 (30 fps)		
			352 x 240 (30 fps)		
		800 x 600 (15 fps)	800 x 600 (15 fps)	800 x 600 (15 fps)	720 x 480 (30 fps)
					640 x 480 (30 fps)
					352 x 240 (30 fps)
			720 x 480 (15 fps)	720 x 480 (15 fps)	720 x 480 (15 fps)
	640 x 480 (30 fps)				
	352 x 240 (30 fps)				
	640 x 480 (30 fps)	640 x 480 (30 fps)	640 x 480 (30 fps)	640 x 480 (30 fps)	
				352 x 240 (30 fps)	
	352 x 240 (30 fps)	352 x 240 (30 fps)	352 x 240 (30 fps)	352 x 240 (30 fps)	
	1280 x 720 (15 fps)	1280 x 720 (15 fps)	1280 x 720 (15 fps)	720 x 480 (30 fps)	
				640 x 480 (30 fps)	
				352 x 240 (30 fps)	
			800 x 600 (30 fps)	800 x 600 (30 fps)	800 x 600 (30 fps)
		640 x 480 (30 fps)			
		352 x 240 (30 fps)			
		720 x 480 (30 fps)	720 x 480 (30 fps)	720 x 480 (30 fps)	720 x 480 (30 fps)
					640 x 480 (30 fps)
		640 x 480 (30 fps)	640 x 480 (30 fps)	640 x 480 (30 fps)	640 x 480 (30 fps)
		352 x 240 (30 fps)	352 x 240 (30 fps)	352 x 240 (30 fps)	352 x 240 (30 fps)
		1280 x 720 (30 fps)	1280 x 720 (30 fps)	1280 x 720 (30 fps)	1280 x 720 (30 fps)
		1024 x 768 (15 fps)	800 x 600 (30 fps)	800 x 600 (30 fps)	720 x 480 (30 fps)
					640 x 480 (30 fps)
					352 x 240 (30 fps)
			720 x 480 (30 fps)	720 x 480 (30 fps)	720 x 480 (30 fps)
	640 x 480 (30 fps)				
	640 x 480 (30 fps)	640 x 480 (30 fps)	640 x 480 (30 fps)	640 x 480 (30 fps)	
				640 x 480 (30 fps)	
				352 x 240 (30 fps)	
	1024 x 768 (30 fps)	1024 x 768 (30 fps)	1024 x 768 (30 fps)	720 x 480 (30 fps)	
640 x 480 (30 fps)					
352 x 240 (30 fps)					
800 x 600 (15 fps)	800 x 600 (15 fps)	800 x 600 (15 fps)	800 x 600 (15 fps)		
800 x 600 (30 fps)	800 x 600 (30 fps)	800 x 600 (30 fps)	640 x 480 (30 fps)		
			352 x 240 (30 fps)		
			720 x 480 (30 fps)		
	720 x 480 (30 fps)	720 x 480 (30 fps)	720 x 480 (30 fps)	640 x 480 (30 fps)	
				352 x 240 (30 fps)	
				640 x 480 (30 fps)	
720 x 480 (30 fps)	720 x 480 (30 fps)	720 x 480 (30 fps)	720 x 480 (30 fps)		
			640 x 480 (30 fps)		
	640 x 480 (30 fps)	640 x 480 (30 fps)	640 x 480 (30 fps)	640 x 480 (30 fps)	
				352 x 240 (30 fps)	
640 x 480 (30 fps)	640 x 480 (30 fps)	640 x 480 (30 fps)	640 x 480 (30 fps)		
			640 x 480 (30 fps)		
			352 x 240 (30 fps)		
			352 x 240 (30 fps)		
1280 x 1024 (30 fps)	800 x 600 (30 fps)	800 x 600 (30 fps)	800 x 600 (30 fps)		
	720 x 480 (30 fps)	720 x 480 (30 fps)	720 x 480 (30 fps)		
	640 x 480 (30 fps)	640 x 480 (30 fps)	640 x 480 (30 fps)		
	352 x 240 (30 fps)	352 x 240 (30 fps)	352 x 240 (30 fps)		

H.264 + H.264 + H.264 + H.264 / MJPEG					
H.264-1	H.264-2	H.264-3	H.264-4 / MJPEG		
1280 x 720 (15 fps)	1280 x 720 (15 fps)	1280 x 720 (15 fps)	720 x 480 (30 fps) 640 x 480 (30 fps)		
		1280 x 720 (30 fps)	352 x 240 (30 fps)		
		800 x 600 (30 fps)	720 x 480 (30 fps) 640 x 480 (30 fps)		
		720 x 480 (30 fps)	720 x 480 (30 fps) 640 x 480 (30 fps)		
		640 x 480 (30 fps)	640 x 480 (30 fps)		
	1280 x 720 (30 fps)	1280 x 720 (30 fps)	800 x 600 (30 fps)	352 x 240 (30 fps)	
			720 x 480 (30 fps)	352 x 240 (30 fps)	
			640 x 480 (30 fps)	352 x 240 (30 fps)	
			352 x 240 (30 fps)	352 x 240 (30 fps)	
	1024 x 768 (15 fps)	1024 x 768 (15 fps)	800 x 600 (30 fps)	720 x 480 (30 fps) 640 x 480 (30 fps)	
	1024 x 768 (30 fps)	1024 x 768 (30 fps)	800 x 600 (30 fps)	352 x 240 (30 fps)	
			720 x 480 (30 fps)	720 x 480 (30 fps) 640 x 480 (30 fps) 352 x 240 (30 fps)	
			640 x 480 (30 fps)	640 x 480 (30 fps) 352 x 240 (30 fps)	
		800 x 600 (30 fps)	800 x 600 (30 fps)	800 x 600 (30 fps)	720 x 480 (30 fps) 640 x 480 (30 fps) 352 x 240 (30 fps)
				720 x 480 (30 fps)	720 x 480 (30 fps) 640 x 480 (30 fps)
				640 x 480 (30 fps)	640 x 480 (30 fps)
	1280 x 720 (30 fps)	1024 x 768 (30 fps)	352 x 240 (30 fps)	352 x 240 (30 fps)	
		800 x 600 (30 fps)	800 x 600 (30 fps)	720 x 480 (30 fps) 640 x 480 (30 fps) 352 x 240 (30 fps)	
			720 x 480 (30 fps)	640 x 480 (30 fps) 352 x 240 (30 fps)	
640 x 480 (30 fps)			640 x 480 (30 fps) 352 x 240 (30 fps)		
720 x 480 (30 fps)		720 x 480 (30 fps)	640 x 480 (30 fps) 352 x 240 (30 fps)		
		640 x 480 (30 fps)	640 x 480 (30 fps) 352 x 240 (30 fps)		
		352 x 240 (30 fps)	352 x 240 (30 fps)		
640 x 480 (30 fps)		640 x 480 (30 fps)	640 x 480 (30 fps) 352 x 240 (30 fps)		
352 x 240 (30 fps)		352 x 240 (30 fps)	352 x 240 (30 fps)		
1024 x 768 (15 fps)		1024 x 768 (15 fps)	800 x 600 (30 fps)	720 x 480 (30 fps) 640 x 480 (30 fps)	
	1024 x 768 (30 fps)	800 x 600 (30 fps)	352 x 240 (30 fps)		
		720 x 480 (30 fps)	720 x 480 (30 fps) 640 x 480 (30 fps) 352 x 240 (30 fps)		
		640 x 480 (30 fps)	640 x 480 (30 fps)		
	800 x 600 (30 fps)	800 x 600 (30 fps)	720 x 480 (30 fps) 640 x 480 (30 fps)		



## 2M- Triple Streams

H.264-1 + H.264-2 + H.264-3 / MJPEG			
H.264-1	H.264-2	H.264-3 / MJPEG	
1920 x 1080 (15 fps)	1280 x 1024 (15 fps)	800 x 600 (15 fps)	
		720 x 480 (15 fps)	
		640 x 480 (15 fps)	
		352 x 240 (30 fps)	
	1280 x 720 (15 fps)	1280 x 720 (15 fps)	1280 x 720 (15 fps)
			800 x 600 (15 fps)
			720 x 480 (30 fps)
			640 x 480 (30 fps)
			352 x 240 (30 fps)
	1024 x 768 (15 fps)	1024 x 768 (15 fps)	800 x 600 (30 fps)
			720 x 480 (30 fps)
	1024 x 768 (30 fps)	352 x 240 (30 fps)	640 x 480 (30 fps)
	800 x 600 (15 fps)	800 x 600 (30 fps)	800 x 600 (30 fps)
	800 x 600 (30 fps)	800 x 600 (30 fps)	720 x 480 (30 fps)
640 x 480 (30 fps)			
352 x 240 (30 fps)			
720 x 480 (30 fps)	720 x 480 (30 fps)	720 x 480 (30 fps)	
		640 x 480 (30 fps)	
		352 x 240 (30 fps)	
640 x 480 (30 fps)	640 x 480 (30 fps)	640 x 480 (30 fps)	
		352 x 240 (30 fps)	
352 x 240 (30fps)	352 x 240 (30fps)	352 x 240 (30fps)	
1280 x 1024 (15 fps)	1280 x 1024 (15 fps)	1280 x 720 (15 fps)	
		800 x 600 (30 fps)	
		720 x 480 (30 fps)	
		640 x 480 (30 fps)	
		352 x 240 (30 fps)	
	1280 x 720 (15 fps)	1280 x 720 (15 fps)	1280 x 720 (15 fps)
			800 x 600 (30 fps)
	1280 x 720 (30 fps)	1280 x 720 (30 fps)	720 x 480 (30 fps)
			640 x 480 (30 fps)
			352 x 240 (30 fps)
	1024 x 768 (30 fps)	1024 x 768 (30 fps)	800 x 600 (30 fps)
			720 x 480 (30 fps)
			640 x 480 (30 fps)
			352 x 240 (30 fps)
800 x 600 (30 fps)	800 x 600 (30 fps)	800 x 600 (30 fps)	
		720 x 480 (30 fps)	
		640 x 480 (30 fps)	
720 x 480 (30 fps)	720 x 480 (30 fps)	720 x 480 (30 fps)	
800 x 600 (30 fps)	352 x 240 (30 fps)	640 x 480 (30 fps)	
1280 x 1024 (30 fps)	720 x 480 (30 fps)	640 x 480 (30 fps)	
		352 x 240 (30 fps)	
		640 x 480 (30 fps)	
		352 x 240 (30 fps)	
		352 x 240 (30 fps)	
1280 x 720 (15 fps)	1280 x 720 (15 fps)	1280 x 720 (30 fps)	
		800 x 600 (30 fps)	
	1280 x 720 (30 fps)	1280 x 720 (30 fps)	720 x 480 (30 fps)
			640 x 480 (30 fps)
			800 x 600 (30 fps)
	1024 x 768 (30 fps)	1024 x 768 (30 fps)	720 x 480 (30 fps)
640 x 480 (30 fps)			



H.264-1 + H.264-2 + H.264-3 / MJPEG			
H.264-1	H.264-2	H.264-3 / MJPEG	
1280 x 720 (30 fps)	1280 x 720 (30 fps)	352 x 240 (30 fps)	
	1024 x 768 (30 fps)	352 x 240 (30 fps)	
	800 x 600 (30 fps)		800 x 600 (30 fps)
			720 x 480 (30 fps)
			640 x 480 (30 fps)
			352 x 240 (30 fps)
	720 x 480 (30 fps)		720 x 480 (30 fps)
			640 x 480 (30 fps)
352 x 240 (30 fps)			
640 x 480 (30 fps)		640 x 480 (30 fps)	
352 x 240 (30 fps)		352 x 240 (30 fps)	
1024 x 768 (15 fps)	1024 x 768 (30 fps)	800 x 600 (30 fps)	
1024 x 768 (30 fps)	1024 x 768 (30 fps)	720 x 480 (30 fps)	
		640 x 480 (30 fps)	
		352 x 240 (30 fps)	
	800 x 600 (30 fps)		800 x 600 (30 fps)
			720 x 480 (30 fps)
			640 x 480 (30 fps)
			352 x 240 (30 fps)
	720 x 480 (30 fps)		720 x 480 (30 fps)
			640 x 480 (30 fps)
			352 x 240 (30 fps)
	640 x 480 (30 fps)		640 x 480 (30 fps)
			352 x 240 (30 fps)
352 x 240 (30 fps)		352 x 240 (30 fps)	
800 x 600 (30 fps)	800 x 600 (30 fps)	800 x 600 (30 fps)	
		720 x 480 (30 fps)	
		640 x 480 (30 fps)	
		352 x 240 (30 fps)	
	720 x 480 (30 fps)		720 x 480 (30 fps)
			640 x 480 (30 fps)
			352 x 240 (30 fps)
			352 x 240 (30 fps)
640 x 480 (30 fps)		640 x 480 (30 fps)	
		352 x 240 (30 fps)	
		352 x 240 (30 fps)	
		352 x 240 (30 fps)	
720 x 480 (30 fps)	720 x 480 (30 fps)	720 x 480 (30 fps)	
		640 x 480 (30 fps)	
		352 x 240 (30 fps)	
	640 x 480 (30 fps)		640 x 480 (30 fps)
352 x 240 (30 fps)		352 x 240 (30 fps)	
640 x 480 (30 fps)	640 x 480 (30 fps)	640 x 480 (30 fps)	
		352 x 240 (30 fps)	
		352 x 240 (30 fps)	
352 x 240 (30 fps)	352 x 240 (30 fps)	352 x 240 (30 fps)	

## 2M- Dual Streams

H.264-1 + H.264-2 / MJPEG		
H.264-1	H.264-2 / MJPEG	BNC SUPPORT
1920 x 1080 (15 fps)	1280 x 1024 (15 fps)	-
	1280 x 720 (30 fps)	-
	1024 x 768 (30 fps)	-
	800 x 600 (30 fps)	-
	720 x 480 (30 fps)	√
	640 x 480 (30 fps)	√
	352 x 240 (30 fps)	√
1280 x 1024 (30 fps)	1280 x 1024 (15 fps)	√
	1280 x 720 (15 fps)	-
	1024 x 768 (15 fps)	-
	800 x 600 (30 fps)	-
	720 x 480 (30 fps)	√
	640 x 480 (30 fps)	√
1280 x 720 (30 fps)	352 x 240 (30 fps)	√
	1280 x 720 (30 fps)	√
	1024 x 768 (30 fps)	-
	800 x 600 (30 fps)	-
	720 x 480 (30 fps)	√
	640 x 480 (30 fps)	√
1024 x 768 (30 fps)	352 x 240 (30 fps)	√
	1024 x 768 (30 fps)	√
	800 x 600 (30 fps)	-
	720 x 480 (30 fps)	√
	640 x 480 (30 fps)	√
800 x 600 (30 fps)	352 x 240 (30 fps)	√
	800 x 600 (30 fps)	√
	720 x 480 (30 fps)	√
	640 x 480 (30 fps)	√
720 x 480 (30 fps)	352 x 240 (30 fps)	√
	720 x 480 (30 fps)	√
	640 x 480 (30 fps)	√
640 x 480 (30 fps)	352 x 240 (30 fps)	√
	640 x 480 (30 fps)	√
352 x 240 (30 fps)	352 x 240 (30 fps)	-

## 2M- Single Stream

H.264 Only	BNC SUPPORT
1920 x 1080 (15 fps) Low Latency	-
1920 x 1080 (15 fps)	√
1280 x 1024 (30 fps)	√
1280 x 720 (30 fps)	√
1024 x 768 (30 fps)	√
800 x 600 (30 fps)	√
720 x 480 (30 fps)	√
640 x 480 (30 fps)	√
352 x 240 (30 fps)	-

MJPEG Only	BNC SUPPORT
1920 x 1080 (15 fps)	√
1280 x 1024 (30 fps)	√
1280 x 720 (30 fps)	√
1024 x 768 (30 fps)	√
800 x 600 (30 fps)	√
720 x 480 (30 fps)	√
640 x 480 (30 fps)	√
352 x 240 (30 fps)	-

## 2M Real time / 3M / 5M- Quad Streams

H.264 + H.264 + H.264 + H.264 / MJPEG				
H.264-1	H.264-2	H.264-3	H.264-4 / MJPEG	
2592 x 1944 (12 fps)	720 x 480 (12 fps)	720 x 480 (12 fps)	352 x 240 (12 fps)	
		640 x 480 (12 fps)	640 x 480 (12 fps)	
		352 x 240 (12 fps)	352 x 240 (12 fps)	
	640 x 480 (12 fps)	640 x 480 (12 fps)	640 x 480 (12 fps)	640 x 480 (12 fps)
		640 x 480 (12 fps)	352 x 240 (12 fps)	352 x 240 (12 fps)
		352 x 240 (12 fps)	352 x 240 (12 fps)	352 x 240 (12 fps)

\*The resolution is for 5M Model only.

H.264 + H.264 + H.264 + H.264 / MJPEG					
H.264-1	H.264-2	H.264-3	H.264-4 / MJPEG		
2048 x 1536 (15 fps)	1280 x 720 (15 fps)	720 x 480 (15 fps)	640 x 480 (15 fps)		
			352 x 240 (15 fps)		
		640 x 480 (15 fps)	640 x 480 (15 fps)		
	800 x 600 (15 fps)	800 x 600 (15 fps)	352 x 240 (15 fps)	352 x 240 (15 fps)	
			800 x 600 (15 fps)	720 x 480 (15 fps)	
				640 x 480 (15 fps)	
		720 x 480 (15 fps)	720 x 480 (15 fps)	720 x 480 (15 fps)	640 x 480 (15 fps)
				640 x 480 (15 fps)	352 x 240 (15 fps)
				352 x 240 (15 fps)	352 x 240 (15 fps)
	720 x 480 (15 fps)	720 x 480 (15 fps)	640 x 480 (15 fps)	640 x 480 (15 fps)	
				352 x 240 (15 fps)	
				352 x 240 (15 fps)	
		640 x 480 (15 fps)	640 x 480 (15 fps)	640 x 480 (15 fps)	640 x 480 (15 fps)
				352 x 240 (15 fps)	352 x 240 (15 fps)
				352 x 240 (15 fps)	352 x 240 (15 fps)

\*The resolution is for 3M & 5M Model only.

H.264 + H.264 + H.264 + H.264 / MJPEG				
H.264-1	H.264-2	H.264-3	H.264-4 / MJPEG	
1920 x 1080 (15 fps)	1280 x 1024 (15 fps)	1280 x 720 (15 fps)	720 x 480 (15 fps)	
			640 x 480 (15 fps)	
			352 x 240 (30 fps)	
		1280 x 720 (15 fps)	800 x 600 (15 fps)	720 x 480 (30 fps)
				640 x 480 (30 fps)
			800 x 600 (30 fps)	352 x 240 (30 fps)
				720 x 480 (30 fps)
	720 x 480 (15 fps)		720 x 480 (30 fps)	
			640 x 480 (30 fps)	
	720 x 480 (30 fps)	640 x 480 (30 fps)		
		352 x 240 (30 fps)		
	1280 x 720 (30 fps)	1280 x 720 (15 fps)	800 x 600 (30 fps)	720 x 480 (30 fps)
				640 x 480 (30 fps)
			720 x 480 (30 fps)	720 x 480 (30 fps)
				640 x 480 (30 fps)
	1024 x 768 (15 fps)	800 x 600 (30 fps)	720 x 480 (30 fps)	
			640 x 480 (30 fps)	
			352 x 240 (30 fps)	
	1024 x 768 (30 fps)	800 x 600 (30 fps)	720 x 480 (30 fps)	
			640 x 480 (30 fps)	
			352 x 240 (30 fps)	
	800 x 600 (30 fps)	800 x 600 (30 fps)	720 x 480 (30 fps)	720 x 480 (30 fps)
				640 x 480 (30 fps)
				352 x 240 (30 fps)
		720 x 480 (30 fps)	720 x 480 (30 fps)	640 x 480 (30 fps)
				352 x 240 (30 fps)
			640 x 480 (30 fps)	640 x 480 (30 fps)
				352 x 240 (30 fps)
		720 x 480 (30 fps)	720 x 480 (30 fps)	720 x 480 (30 fps)
				640 x 480 (30 fps)
				352 x 240 (30 fps)
	640 x 480 (30 fps)	640 x 480 (30 fps)	640 x 480 (30 fps)	
352 x 240 (30 fps)				
352 x 240 (30 fps)				
1920 x 1080 (30 fps)	352 x 240 (30 fps)	352 x 240 (30 fps)	352 x 240 (30 fps)	



H.264 + H.264 + H.264 + H.264 / MJPEG				
H.264-1	H.264-2	H.264-3	H.264-4 / MJPEG	
1280 x 720 (30 fps)	1280 x 720 (30 fps)	800 x 600 (30 fps)	352 x 240 (30 fps)	
		720 x 480 (30 fps)	352 x 240 (30 fps)	
		640 x 480 (30 fps)	352 x 240 (30 fps)	
		352 x 240 (30 fps)	352 x 240 (30 fps)	
	1024 x 768 (30 fps)	800 x 600 (30 fps)	800 x 600 (30 fps)	352 x 240 (30 fps)
			720 x 480 (30 fps)	720 x 480 (30 fps)
			640 x 480 (30 fps)	640 x 480 (30 fps)
			352 x 240 (30 fps)	352 x 240 (30 fps)
	800 x 600 (30 fps)	720 x 480 (30 fps)	800 x 600 (30 fps)	720 x 480 (30 fps)
			720 x 480 (30 fps)	640 x 480 (30 fps)
			640 x 480 (30 fps)	640 x 480 (30 fps)
			352 x 240 (30 fps)	352 x 240 (30 fps)
	720 x 480 (30 fps)	640 x 480 (30 fps)	800 x 600 (30 fps)	640 x 480 (30 fps)
			720 x 480 (30 fps)	640 x 480 (30 fps)
			640 x 480 (30 fps)	352 x 240 (30 fps)
			352 x 240 (30 fps)	352 x 240 (30 fps)
	640 x 480 (30 fps)	352 x 240 (30 fps)	800 x 600 (30 fps)	640 x 480 (30 fps)
			720 x 480 (30 fps)	352 x 240 (30 fps)
			640 x 480 (30 fps)	352 x 240 (30 fps)
			352 x 240 (30 fps)	352 x 240 (30 fps)
	1024 x 768 (30 fps)	1024 x 768 (30 fps)	800 x 600 (30 fps)	720 x 480 (30 fps)
			720 x 480 (30 fps)	640 x 480 (30 fps)
			640 x 480 (30 fps)	640 x 480 (30 fps)
			352 x 240 (30 fps)	352 x 240 (30 fps)
800 x 600 (30 fps)		720 x 480 (30 fps)	800 x 600 (30 fps)	720 x 480 (30 fps)
			720 x 480 (30 fps)	640 x 480 (30 fps)
			640 x 480 (30 fps)	640 x 480 (30 fps)
			352 x 240 (30 fps)	352 x 240 (30 fps)
720 x 480 (30 fps)		640 x 480 (30 fps)	800 x 600 (30 fps)	640 x 480 (30 fps)
			720 x 480 (30 fps)	640 x 480 (30 fps)
			640 x 480 (30 fps)	352 x 240 (30 fps)
			352 x 240 (30 fps)	352 x 240 (30 fps)
640 x 480 (30 fps)		352 x 240 (30 fps)	800 x 600 (30 fps)	640 x 480 (30 fps)
			720 x 480 (30 fps)	352 x 240 (30 fps)
			640 x 480 (30 fps)	352 x 240 (30 fps)
			352 x 240 (30 fps)	352 x 240 (30 fps)

H.264 + H.264 + H.264 + H.264 / MJPEG						
H.264-1	H.264-2	H.264-3	H.264-4 / MJPEG			
800 x 600 (30 fps)	800 x 600 (30 fps)	800 x 600 (30 fps)	352 x 240 (30 fps)			
		720 x 480 (30 fps)	720 x 480 (30 fps)	720 x 480 (30 fps)		
			640 x 480 (30 fps)	640 x 480 (30 fps)		
		720 x 480 (30 fps)	640 x 480 (30 fps)	640 x 480 (30 fps)	640 x 480 (30 fps)	
	640 x 480 (30 fps)		352 x 240 (30 fps)	352 x 240 (30 fps)		
			720 x 480 (30 fps)	720 x 480 (30 fps)		
	640 x 480 (30 fps)		640 x 480 (30 fps)	640 x 480 (30 fps)	640 x 480 (30 fps)	
		352 x 240 (30 fps)	352 x 240 (30 fps)	352 x 240 (30 fps)		
	720 x 480 (30 fps)	720 x 480 (30 fps)	720 x 480 (30 fps)	720 x 480 (30 fps)		
				640 x 480 (30 fps)	640 x 480 (30 fps)	
			640 x 480 (30 fps)	640 x 480 (30 fps)	640 x 480 (30 fps)	640 x 480 (30 fps)
				352 x 240 (30 fps)	352 x 240 (30 fps)	352 x 240 (30 fps)
640 x 480 (30 fps)		640 x 480 (30 fps)	640 x 480 (30 fps)	640 x 480 (30 fps)		
			352 x 240 (30 fps)	352 x 240 (30 fps)		
		352 x 240 (30 fps)	352 x 240 (30 fps)	352 x 240 (30 fps)	352 x 240 (30 fps)	
			640 x 480 (30 fps)	640 x 480 (30 fps)	640 x 480 (30 fps)	
640 x 480 (30 fps)		640 x 480 (30 fps)	640 x 480 (30 fps)	640 x 480 (30 fps)		
			352 x 240 (30 fps)	352 x 240 (30 fps)		
		352 x 240 (30 fps)	352 x 240 (30 fps)	352 x 240 (30 fps)	352 x 240 (30 fps)	
			640 x 480 (30 fps)	640 x 480 (30 fps)	640 x 480 (30 fps)	
352 x 240 (30 fps)	352 x 240 (30 fps)	352 x 240 (30 fps)	352 x 240 (30 fps)			

## 2M Real time / 3M / 5M- Triple Streams

H.264-1 + H.264-2 + H.264-3 / MJPEG		
H.264-1	H.264-2	H.264-3 / MJPEG
2592 x 1944 (12 fps)	720 x 480 (12 fps)	720 x 480 (12 fps)
		640 x 480 (12 fps)
		352 x 240 (12 fps)
	640 x 480 (12 fps)	640 x 480 (12 fps)
		640 x 480 (12 fps)
		352 x 240 (12 fps)

\*The resolution is for 5M Model only.

H.264-1 + H.264-2 + H.264-3 / MJPEG		
H.264-1	H.264-2	H.264-3 / MJPEG
2048 x 1536 (15 fps)	1280 x 720 (15 fps)	720 x 480 (15 fps)
		640 x 480 (15 fps)
		352 x 240 (15 fps)
	800 x 600 (15 fps)	800 x 600 (15 fps)
		720 x 480 (15 fps)
		640 x 480 (15 fps)
	720 x 480 (15 fps)	352 x 240 (15 fps)
		720 x 480 (15 fps)
		640 x 480 (15 fps)
	640 x 480 (15 fps)	352 x 240 (15 fps)
		640 x 480 (15 fps)
		352 x 240 (15 fps)
	352 x 240 (15 fps)	352 x 240 (15 fps)

\*The resolution is for 3M & 5M Model only.

H.264-1 + H.264-2 + H.264-3 / MJPEG		
H.264-1	H.264-2	H.264-3 / MJPEG
1920 x 1080 (15 fps)	1280 x 1024 (15 fps)	1280 x 720 (15 fps)
		800 x 600 (30 fps)
		720 x 480 (30 fps)
		640 x 480 (30 fps)
		352 x 240 (30 fps)
	1280 x 720 (15 fps)	1280 x 720 (30 fps)
		800 x 600 (30 fps)
	1280 x 720 (30 fps)	720 x 480 (30 fps)
		640 x 480 (30 fps)
		352 x 240 (30 fps)
	1024 x 768 (30 fps)	800 x 600 (30 fps)
		720 x 480 (30 fps)
		640 x 480 (30 fps)
		352 x 240 (30 fps)
	800 x 600 (30 fps)	800 x 600 (30 fps)
		720 x 480 (30 fps)
		640 x 480 (30 fps)
		352 x 240 (30 fps)
	720 x 480 (30 fps)	720 x 480 (30 fps)
		640 x 480 (30 fps)
		352 x 240 (30 fps)
640 x 480 (30 fps)	640 x 480 (30 fps)	
	352 x 240 (30 fps)	
1920 x 1080 (30 fps)	352 x 240 (30 fps)	352 x 240 (30 fps)



H.264-1 + H.264-2 + H.264-3 / MJPEG		
H.264-1	H.264-2	H.264-3 / MJPEG
1280 x 1024 (15 fps)	1280 x 1024 (15 fps)	1280 x 720 (30 fps)
		800 x 600 (30 fps)
	1280 x 1024 (30 fps)	720 x 480 (30 fps)
		640 x 480 (30 fps)
	1280 x 720 (15 fps)	352 x 240 (30 fps)
		1280 x 720 (30 fps)
1280 x 720 (30 fps)	800 x 600 (30 fps)	
	720 x 480 (30 fps)	
1024 x 768 (30 fps)	640 x 480 (30 fps)	
	800 x 600 (30 fps)	
1280 x 1024 (30 fps)	1280 x 720 (30 fps)	720 x 480 (30 fps)
	1024 x 768 (30 fps)	640 x 480 (30 fps)
		352 x 240 (30 fps)
		800 x 600 (30 fps)
	800 x 600 (30 fps)	720 x 480 (30 fps)
		640 x 480 (30 fps)
	720 x 480 (30 fps)	640 x 480 (30 fps)
352 x 240 (30 fps)		
352 x 240 (30 fps)		
640 x 480 (30 fps)	640 x 480 (30 fps)	
	352 x 240 (30 fps)	
352 x 240 (30 fps)	352 x 240 (30 fps)	
1280 x 720 (15 fps)	1280 x 720 (30 fps)	1280 x 720 (30 fps)
1280 x 720 (30 fps)	1280 x 720 (30 fps)	800 x 600 (30 fps)
		720 x 480 (30 fps)
		640 x 480 (30 fps)
		352 x 240 (30 fps)
	1024 x 768 (30 fps)	800 x 600 (30 fps)
		720 x 480 (30 fps)
		640 x 480 (30 fps)
		352 x 240 (30 fps)
	800 x 600 (30 fps)	800 x 600 (30 fps)
		720 x 480 (30 fps)
		640 x 480 (30 fps)
		352 x 240 (30 fps)
	720 x 480 (30 fps)	720 x 480 (30 fps)
		640 x 480 (30 fps)
352 x 240 (30 fps)		
640 x 480 (30 fps)	640 x 480 (30 fps)	
	352 x 240 (30 fps)	
352 x 240 (30 fps)	352 x 240 (30 fps)	
1024 x 768 (30 fps)	1024 x 768 (30 fps)	800 x 600 (30 fps)
		720 x 480 (30 fps)
		640 x 480 (30 fps)
		352 x 240 (30 fps)
	800 x 600 (30 fps)	800 x 600 (30 fps)
		720 x 480 (30 fps)
		640 x 480 (30 fps)
		352 x 240 (30 fps)
	720 x 480 (30 fps)	720 x 480 (30 fps)
		640 x 480 (30 fps)
		352 x 240 (30 fps)
	640 x 480 (30 fps)	640 x 480 (30 fps)
		352 x 240 (30 fps)
352 x 240 (30 fps)	352 x 240 (30 fps)	

H.264-1 + H.264-2 + H.264-3 / MJPEG			
H.264-1	H.264-2	H.264-3 / MJPEG	
800 x 600 (30 fps)	800 x 600 (30 fps)	800 x 600 (30 fps)	
		720 x 480 (30 fps)	
		640 x 480 (30 fps)	
		352 x 240 (30 fps)	
	720 x 480 (30 fps)	720 x 480 (30 fps)	720 x 480 (30 fps)
			640 x 480 (30 fps)
			352 x 240 (30 fps)
			352 x 240 (30 fps)
	640 x 480 (30 fps)	640 x 480 (30 fps)	640 x 480 (30 fps)
			352 x 240 (30 fps)
			352 x 240 (30 fps)
			352 x 240 (30 fps)
720 x 480 (30 fps)	720 x 480 (30 fps)	720 x 480 (30 fps)	
		640 x 480 (30 fps)	
		352 x 240 (30 fps)	
	640 x 480 (30 fps)	640 x 480 (30 fps)	640 x 480 (30 fps)
			352 x 240 (30 fps)
			352 x 240 (30 fps)
640 x 480 (30 fps)	640 x 480 (30 fps)	640 x 480 (30 fps)	
		352 x 240 (30 fps)	
		352 x 240 (30 fps)	
352 x 240 (30 fps)	352 x 240 (30 fps)	352 x 240 (30 fps)	

## 2M Real time / 3M / 5M- Dual Streams

H.264-1 + H.264-2 / MJPEG		
H.264-1	H.264-2 / MJPEG	BNC SUPPORT
2592 x 1944 (12 fps)	720 x 480 (12 fps)	-
	640 x 480 (12 fps)	-
	352 x 240 (12 fps)	-

\*The resolution is for 5M Model only.

H.264-1 + H.264-2 / MJPEG		
H.264-1	H.264-2 / MJPEG	BNC SUPPORT
2048 x 1536 (15 fps)	1280 x 720 (15 fps)	-
	800 x 600 (15 fps)	-
	720 x 480 (15 fps)	-
	640 x 480 (15 fps)	-
	352 x 240 (15 fps)	-

\*The resolution is for 3M & 5M Model only.

H.264-1 + H.264-2 / MJPEG		
H.264-1	H.264-2 / MJPEG	BNC SUPPORT
1920 x 1080 (15 fps)	1920 x 1080 (15 fps)	√
	1280 x 1024 (30 fps)	-
	1280 x 720 (30 fps)	-
	1024 x 768 (30 fps)	-
	800 x 600 (30 fps)	-
1920 x 1080 (30 fps)	720 x 480 (30 fps)	√
	640 x 480 (30 fps)	√
	352 x 240 (30 fps)	√
1280 x 1024 (30 fps)	1280 x 1024 (15 fps)	√
	1280 x 720 (30 fps)	-
	1024 x 768 (30 fps)	-
	800 x 600 (30 fps)	-
	720 x 480 (30 fps)	√
	640 x 480 (30 fps)	√
1280 x 720 (30 fps)	352 x 240 (30 fps)	√
	1280 x 720 (30 fps)	√
	1024 x 768 (30 fps)	-
	800 x 600 (30 fps)	-
	720 x 480 (30 fps)	√
	640 x 480 (30 fps)	√
1024 x 768 (30 fps)	352 x 240 (30 fps)	√
	1024 x 768 (30 fps)	√
	800 x 600 (30 fps)	-
	720 x 480 (30 fps)	√
800 x 600 (30 fps)	640 x 480 (30 fps)	√
	352 x 240 (30 fps)	√
	800 x 600 (30 fps)	√
	720 x 480 (30 fps)	√
720 x 480 (30 fps)	640 x 480 (30 fps)	√
	352 x 240 (30 fps)	√
	720 x 480 (30 fps)	√
640 x 480 (30 fps)	640 x 480 (30 fps)	√
	352 x 240 (30 fps)	√
352 x 240 (30 fps)	352 x 240 (30 fps)	-

## 2M Real time / 3M / 5M- Single Streams

H.264 Only	BNC SUPPORT
2592 x 1944 (12 fps)*	-
2048 x 1536 (15 fps)**	-
1920 x 1080 (30 fps) Low Latency***	-
1920 x 1080 (30 fps)	√
1280 x 1024 (30 fps)	√
1280 x 720 (30 fps)	√
1024 x 768 (30 fps)	√
800 x 600 (30 fps)	√
720 x 480 (30 fps)	√
640 x 480 (30 fps)	√
352 x 240 (30 fps)	-

\* The resolution is for 5M Model only.

\*\* The resolution is for 3M & 5M Model only.

\*\*\* 1920 x 1080 (30 fps) Low Latency does not support BNC, 3DNR, Motion Detection and digital zoom.

MJPEG Only	BNC SUPPORT
1920 x 1080 (30 fps)	√
1280 x 1024 (30 fps)	√
1280 x 720 (30 fps)	√
1024 x 768 (30 fps)	√
800 x 600 (30 fps)	√
720 x 480 (30 fps)	√
640 x 480 (30 fps)	√
352 x 240 (30 fps)	-