

VigorSwitch Q1100x

Web Smart Switch

Quick Start Guide

Version: 1.01

Firmware Version: V1.58.0

(For future update, please visit [DrayTek web site](#))

Date: 28 January 2026

Intellectual Property Rights (IPR) Information

Copyrights	© All rights reserved. This publication contains information that is protected by copyright. No part may be reproduced, transmitted, transcribed, stored in a retrieval system, or translated into any language without written permission from the copyright holders.
Trademarks	The following trademarks are used in this document: <ul style="list-style-type: none">● Microsoft is a registered trademark of Microsoft Corp.● Windows 8, 10, 11 and Explorer are trademarks of Microsoft Corp.● Apple and Mac OS are registered trademarks of Apple Inc.● Other products may be trademarks or registered trademarks of their respective manufacturers.

Safety Instructions and Approval

Safety Instructions	<ul style="list-style-type: none">● Read the installation guide thoroughly before you set up the switch.● The switch is a complicated electronic unit that may be repaired only by authorized and qualified personnel. Do not try to open or repair the switch yourself.● Do not place the switch in a damp or humid place, e.g. a bathroom.● The switch should be used in a sheltered area, within a temperature range of +5 to +45 Celsius.● Do not expose the switch to direct sunlight or other heat sources. The housing and electronic components may be damaged by direct sunlight or heat sources.● Do not deploy the cable for LAN connection outdoor to prevent electronic shock hazards.● Do not power off the device when saving configurations or firmware upgrades. It may damage the data in a flash. Please disconnect the Internet connection on the device before powering it off when a TR-069/ ACS server manages the device.● Keep the package out of reach of children.● When you want to dispose of the switch, please follow local regulations on conservation of the environment.
Warranty	We warrant to the original end user (purchaser) that the switch will be free from any defects in workmanship or materials for a period of two (2) years from the date of purchase from the dealer. Please keep your purchase receipt in a safe place as it serves as proof of date of purchase. During the warranty period, and upon proof of purchase, should the product have indications of failure due to faulty workmanship and/or materials, we will, at our discretion, repair or replace the defective products or components, without charge for either parts or labor, to whatever extent we deem necessary to restore the product to proper operating condition. Any replacement will consist of a new or re-manufactured functionally equivalent product of equal value, and will be offered solely at our discretion. This warranty will not apply if the product is modified, misused, tampered with, damaged by an act of God, or subjected to abnormal working conditions. The warranty does not cover the bundled or licensed software of other vendors. Defects which do not significantly affect the usability of the product will not be covered by the warranty. We reserve the right to revise the manual and online documentation and to make changes from time to time in the contents hereof without obligation to notify any person of such revision or changes.



EU Declaration of Conformity

Hereby, DrayTek Corporation declares that the equipment type VigorSwitch is in compliance with EU EMC Directive 2014/30/EU, Low Voltage Directive 2014/35/EU and RoHS 2011/65/EU.

The full text of the EU Declaration of Conformity is available at the following internet address:

<https://fw.draytek.com.tw/VigorSwitch%20Q1100x/Document/CE/>

- Product name: 8x2.5GbE + 2x10G SFP Ports Switch
- Model number: VigorSwitch Q1100x
- Manufacturer: DrayTek Corp.
- Address: No.26, Fushing Rd., Hukou, Hsinchu Industrial Park, Hsinchu 303, Taiwan



Declaration of Conformity

Hereby, DrayTek Corporation declares that the equipment type VigorSwitch is in compliance with The Electromagnetic Compatibility Regulations 2016 (SI 2016 No.1091), The Electrical Equipment (Safety) Regulations 2016 (SI 2016 No.1101), and The Restriction of the Use of Certain Hazardous Substances in Electrical and Electronic Equipment Regulations 2012 (SI 2012 No. 3032).

The full text of the UKCA Declaration of Conformity is available at the following internet address:

<https://fw.draytek.com.tw/VigorSwitch%20Q1100x/Document/CE/>

- Product name: 8x2.5GbE + 2x10G SFP Ports Switch
- Model number: VigorSwitch Q1100x
- Manufacturer: DrayTek Corp.
- Address: No.26, Fushing Rd., Hukou, Hsinchu Industrial Park, Hsinchu 303, Taiwan



UK PSTI STATEMENT OF COMPLIANCE

We, DrayTek Corp., office at No.26, Fushing Rd., Hukou, Hsinchu Industrial Park, Hsinchu 303, Taiwan, declare under our sole responsibility that the product

The full text of the PSTI Declaration of Conformity is available at the following internet address:

<https://fw.draytek.com.tw/UK/PSTI/>

- Product name: L2+ Management Switch
- Model number: VigorSwitch Q1100x
- Manufacturer: DrayTek Corp.
- Address: No.26, Fushing Rd., Hukou, Hsinchu Industrial Park, Hsinchu 303, Taiwan

is in conformity with the relevant UK Statutory Instruments: The Product Security and Telecommunications Infrastructure (Security Requirements for Relevant Connectable Products) Regulations 2023 ("Security Requirements").

Standard	Version
The Product Security and Telecommunications Infrastructure Regulations	2023 Schedule 1
Support Period	3 years after the EOS notification

Please note that this statement of compliance, including the Defined Support Period stated herein, is only applicable to products sold in the UK.

This Statement of Compliance is retained by DrayTek for 10 years after date of issue.

Hsinchu

(place)

25th April, 2025

(date)

Alan Wen
Chief Executive Officer, CEO

(Legal Signature)

Regulatory Information

Federal Communication Commission Interference Statement

This equipment has been tested and found to comply with the limits for a Class A digital device, pursuant to Part 15 of the FCC Rules. These limits are designed to provide reasonable protection against harmful interference in a residential installation. This equipment generates, uses and can radiate radio frequency energy and, if not installed and used in accordance with the instructions, may cause harmful interference to radio communications. However, there is no guarantee that interference will not occur in a particular installation. If this equipment does cause harmful interference to radio or television reception, which can be determined by turning the equipment off and on, the user is encouraged to try to correct the interference by one of the following measures:

- Reorient or relocate the receiving antenna.
- Increase the separation between the equipment and receiver.
- Connect the equipment into an outlet on a circuit different from that to which the receiver is connected.
- Consult the dealer or an experienced radio/TV technician for help.

This device complies with Part 15 of the FCC Rules. Operation is subject to the following two conditions:

- (1) This device may not cause harmful interference, and
- (2) This device may accept any interference received, including interference that may cause undesired operation.

Caution: Any changes or modifications not expressly approved by the party responsible for compliance could void the user's authority to operate the equipment.



More update, please visit www.draytek.com.

USA Local Representative	Company name	ABP International Inc.		
	Address	13988 Diplomat Drive Suite 180 Dallas TX 75234		
	ZIP Code	75234	E-mail	henry@abptech.com
	Contact Person	Mr. Henry N Castillo	Tel.	(972)831-1600 140

Be a Registered Owner

Web registration is preferred. You can register your Vigor switch via <https://myvigor.draytek.com>.

Firmware & Tools Updates

Due to the continuous evolution of DrayTek technology, all switches will be regularly upgraded. Please consult the DrayTek web site for more information on newest firmware, tools and documents.

<https://www.draytek.com>

1. Package Content



VigorSwitch Q1100x

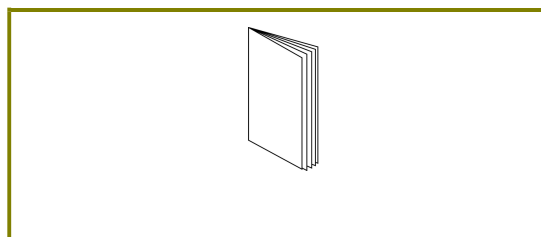

Quick Start Guide

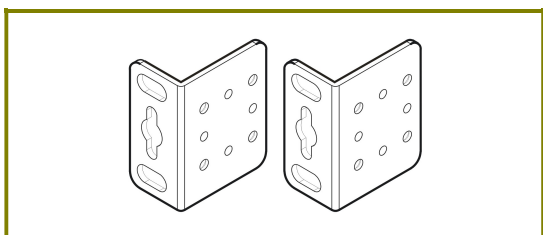

Rack Mount Kit (brackets)

The type of the power adapter for VigorSwitch Q1100x depends on the country that the switch will be installed.

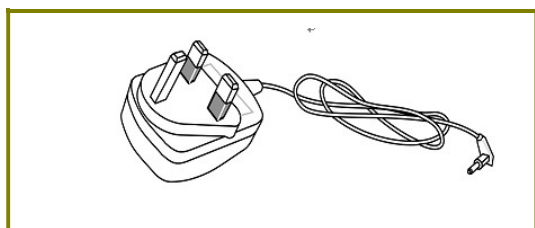

UK-type Power Adapter

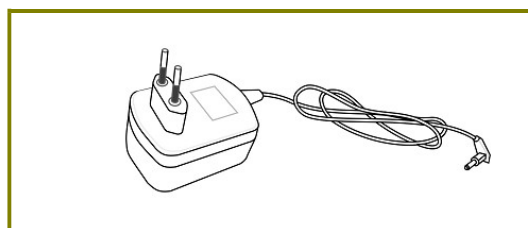

EU-type Power Adapter

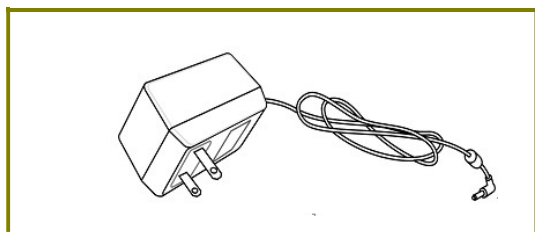

USA/Taiwan-type Power Adapter

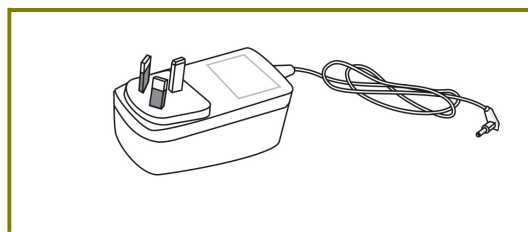

AU/NZ-type Power Adapter

If any of these items is found missing or damaged, please contact your local supplier for replacement.

2. Panel Explanation

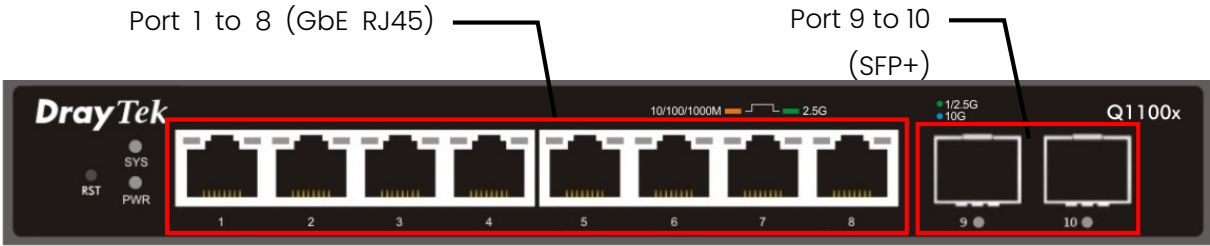

LED	Status	Explanation
PWR/SYS	On (Green)	The switch finishes system booting and the system is ready.
	Blinking (Green)	The switch is powered on and starts system booting.
	Off	The power is off or the system is not ready / malfunctioning.
Port 1 ~ 8 (GbE RJ45)	On (Green)	The device is connected with 2.5Gbps.
	On (Amber)	The device is connected with 1G/100M/10Mbps.
	Blinking	The system is sending or receiving data through the port.
	Off	The port is disconnected or the link is failed.
Port 9 ~10 (SFP+)	On (Amber)	The device is connected with 2.5/1Gbps.
	On (Blue)	The device is connected with 10Gbps.
	Blinking	The system is sending or receiving data through the port.
	Off	The port is disconnected or the link is failed.

Interface	Description
RST	Factory reset button. Press it to reboot the system. (<5 seconds) Press it to reset the system with factory default settings. (>5 seconds)
Port 1 ~ 8 (2.5GbE RJ45)	Port 1 to Port 8 can be used for Ethernet connection.
Port 9 ~ 10 (SFP+)	Port 9 to Port 10 are used for fiber connection.

3. Hardware Installation

Before starting to configure the switch, you have to connect your devices correctly.

3.1 Network Connection

Support Non-PoE devices

- Use the Ethernet cable(s) to connect None-PoE devices to the Vigor switch.
- All device ports are in the same local area network.

Here, we take VigorSwitch Q1100x as an example.

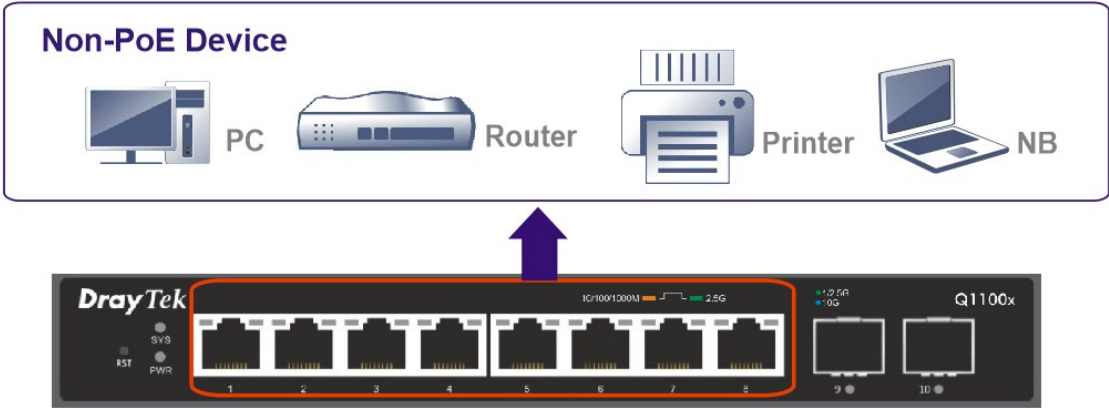

3.2 Wall-Mounted Installation

The switch can be installed easily by using **rack mount kit**.

1. Attach both brackets to Vigor Switch with the fastening screws.
2. Refer to the following picture to find the recommended pairs of screw anchors and screws. Insert two anchors into the wall.
3. Lock the screws on the anchors.
4. Hang the device on the anchors.

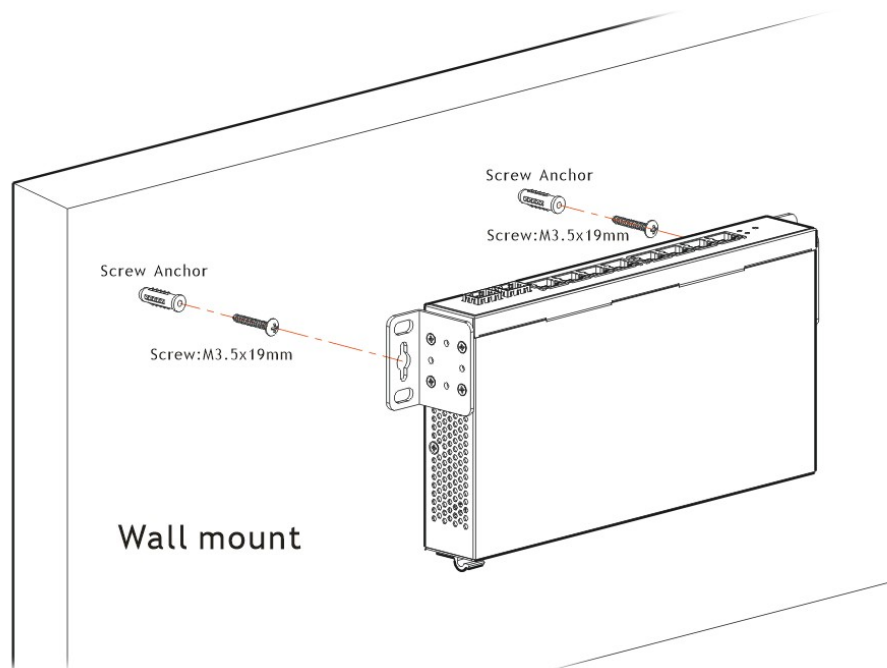
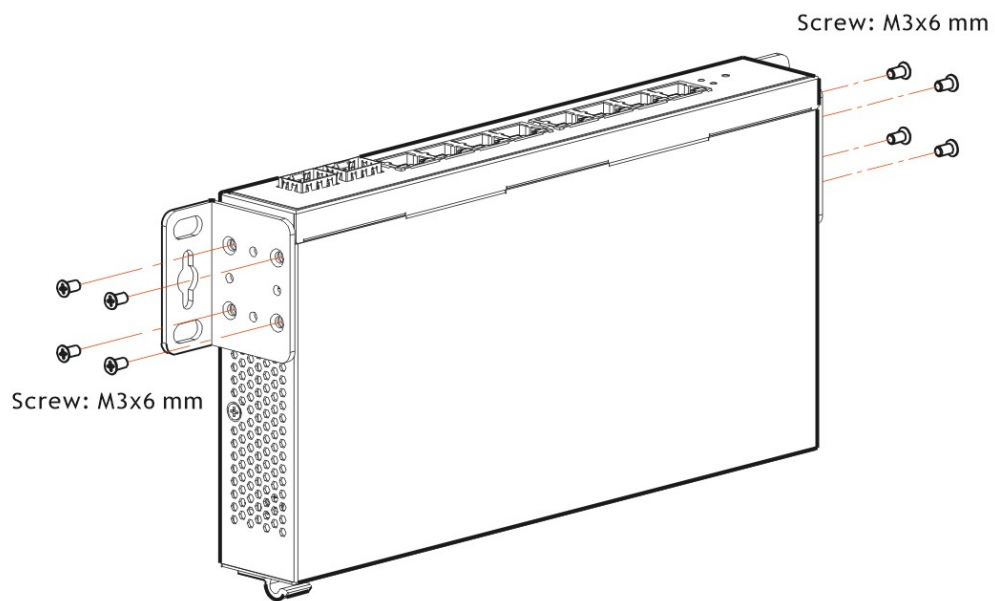

4. Software Configuration

VigorSwitch, for example:
IP Address: 192.168.1.224
Subnet Mask: 255.255.255.0
Default Gateway: 192.168.1.254

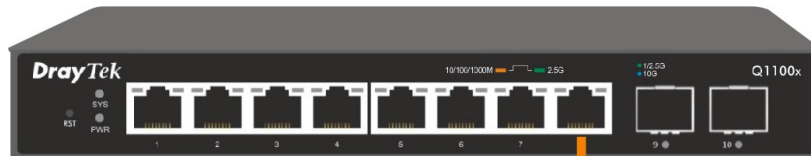

Assign a reasonable IP Address, for example:
IP Address: 192.168.1.100
Subnet Mask: 255.255.255.0
Default Gateway: 192.168.1.254

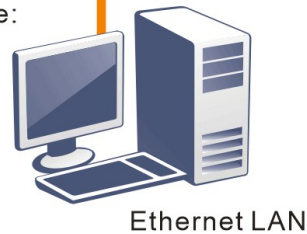

Before using the switch, perform the following steps:

1. Set up a physical path between the configured the switch and a PC by a qualified UTP Cat. 5e cable with RJ-45 connector.
2. If a PC directly connects to the switch, you have to setup the same subnet mask for PC and the switch. Default values of the managed switch are listed as follows:

IP Address	192.168.1.224
Subnet Mask	255.255.255.0
DHCP Client	Enabled (On)
Username	admin
Password	admin

3. After configuring correct IP address on your PC, open your web browser and access switch's IP address.
4. Please enter "admin/admin" as the Username/Password and click **Login**.

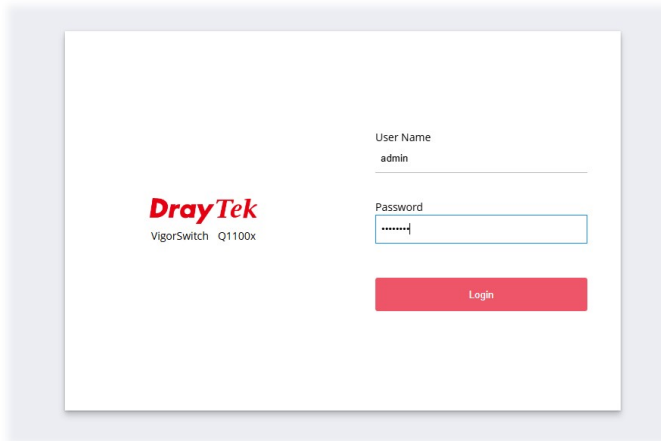

5. Next, a page will appear to guide you change the login password. You **MUST** change the login password before accessing the web user interface. Please click **OK**.

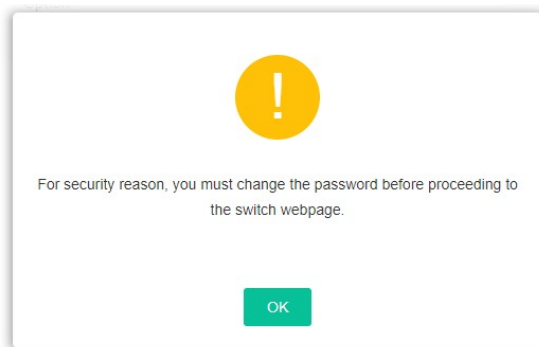

6. Please set a new password with the highest level of strength for network security.

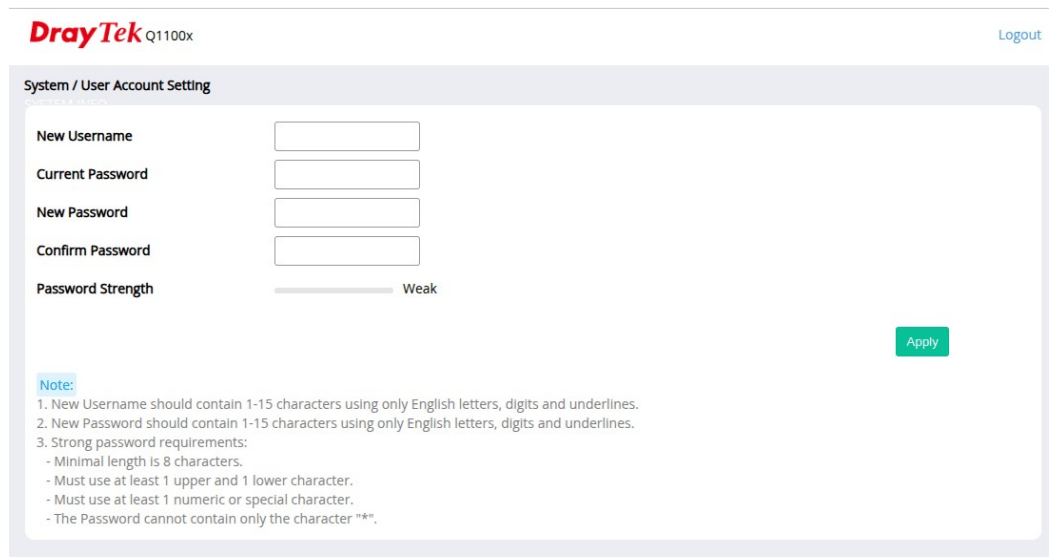

7. Click **OK**. Vigor system will guide you to login with the new password again. Enter the new Username/Password and click **Login**.

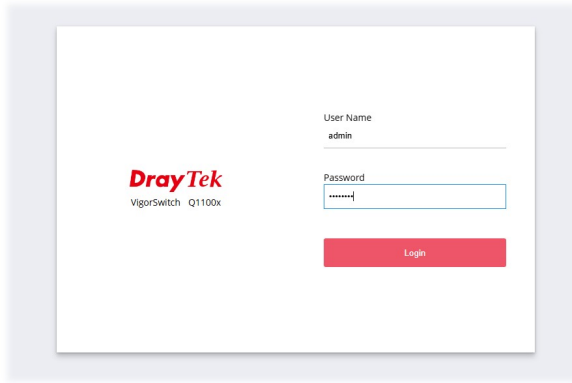

8. Later, the home page of VigorSwitch will be shown on the screen.

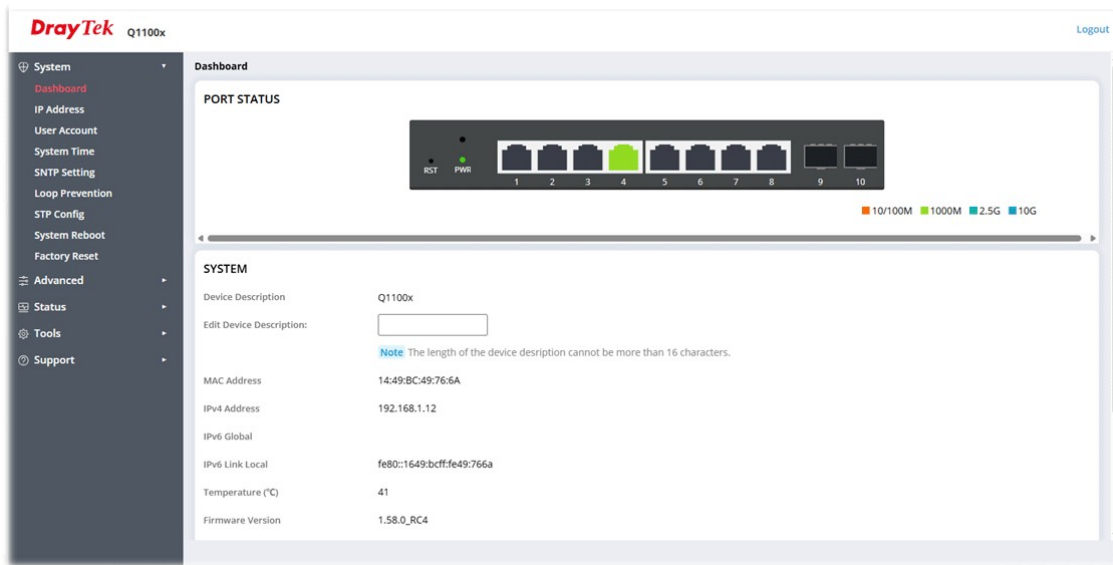

Customer Service

If the switch cannot work correctly after trying many efforts, please contact your dealer for further help right away. For any questions, please feel free to send e-mail to support@draytek.com.